

DEWALT®

ONSITE

NOVITÀ E PROMOZIONI

FEBBRAIO - AGOSTO 2023

THE
NEXT DIMENSION
IN POWER™

NEW
5AH

www.DEWALT.com

GUARANTEED TOUGH.®

NUOVA TRONCATRICE RADIALE 305MM BRUSHLESS 54V



TECNOLOGIA
FRENATA RIGENERATIVA



BATTERIA SINGOLA



DOPPIA INCLINAZIONE DX/SX



PARTENZA LENTA

BASE IN ALLUMINIO
RETTIFICATA

PESO (solo
corpo macchina)
23.2KG

ROTAZIONE DELLA TAVOLA
CON PUNTI PREFISSATI
E SCALA GRADUATA
IN ACCIAIO INCISA

PROLUNGHE DEL PIANO
DI LAVORO CON PRESA
PER IL TRASPORTO

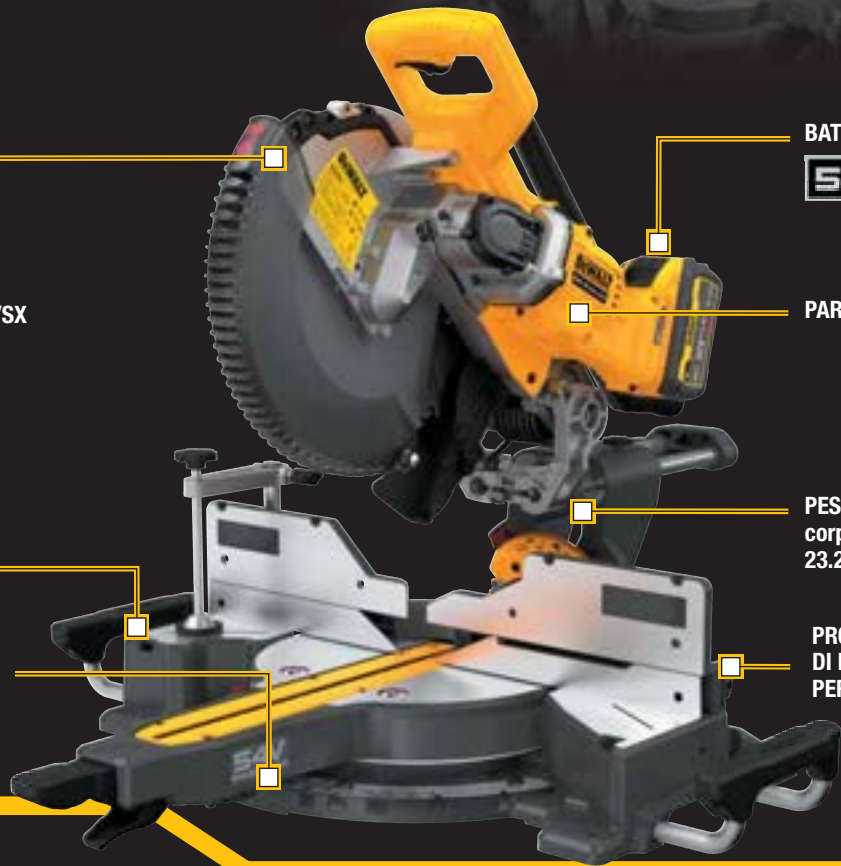

DCS781X2-QW TRONCATRICE RADIALE 305MM 54V

- Doppia inclinazione della testa
- Tecnologia con frenata rigenerativa
- Base in alluminio rettificata
- Rotazione della tavola con punti prefissati e scala graduata in acciaio incisa
- Prolunghe del piano di lavoro con presa per il trasporto
- Partenza lenta
- Peso 23.2kg

DOTAZIONE:

2 batterie XR Flexvolt 9Ah,
caricabatteria, lama per legno 305/30,
60 denti DT99575-QZ,
sacchetto raccogli-polvere, morsetto

	278 mm	112 mm	310 mm	90 mm	19 mm	165 mm
90° 90°						
45° 90°	197 mm	112 mm	219 mm	90 mm		
90° 45° SX	278 mm	60 mm	310 mm	54 mm		
45° 45° dx	296 mm	50 mm	310 mm	40 mm		

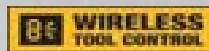
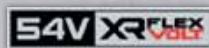

1.459⁰⁰ €

+ IVA



NOVITÀ

ULTRA POTENZA + AUTONOMIA

54V XR FLEX VOLT

ACQUISTA UN ELETTROUTENSILE DELLA GAMMA 54V XR FLEXVOLT ADERENTE ALL'INIZIATIVA, ED AVRAI LA 3^a BATTERIA XR FLEXVOLT DA 6.0AH

OMAGGIO



**DCB546-XJ
BATTERIA 54V 6AH**

NOVITÀ



1.459⁰⁰€
+ IVA



**DCS781X2-QW
TRONCATRICE RADIALE 305MM
54V XR FV 9AH**



1.035⁰⁰€
+ IVA



**DCS777T2-QW
TRONCATRICE RADIALE 216MM
XR FV 6AH**



1.145⁰⁰€
+ IVA



**DCS727T2-QW
TRONCATRICE RADIALE 250MM
XR FV 6AH**



1.210⁰⁰€
+ IVA



**DCS7485T2-QW
SEGA A BANCO 250MM
XR FV 6AH**



1.099⁰⁰€
+ IVA



**DCH892X2-QW
MARTELLO DEMOLITORE
SDS-MAX 19.4J XR FV 9AH**



949⁰⁰€
+ IVA



**DCH832X2-QW
MARTELLO DEMOLITORE
SDS-MAX 10.5J XR FV 9AH**



1.285⁰⁰€
+ IVA



**DCH775X2-QW
MARTELLO DEMO-PERFORATORE
SDS-MAX 52MM 19.4J XR FV 9AH**



1.240⁰⁰€
+ IVA



**DCH735X2-QW
MARTELLO DEMO-PERFORATORE
SDS-MAX 48MM 13.3J XR FV 9AH**



1.140⁰⁰€
+ IVA



**DCH614X2-QW
MARTELLO DEMO-PERFORATORE
SDS-MAX 45MM 10.5J XR FV 9AH**



1.085⁰⁰€
+ IVA



**DCH481X2-QW
MARTELLO DEMO-PERFORATORE
SDS-MAX 40MM 6.1J XR FV 9AH**



1.175⁰⁰ €
+ IVA



**DCH417X2-QW TASSELLATORE
SDS-PLUS 32MM 4.5J XR FV 9AH
DOPPIO MANDRINO + ACCESSORI**



1.080⁰⁰ €
+ IVA



**DCH334X2-QW TASSELLATORE
SDS-PLUS 30MM 3.5J XR FV 9AH
DOPPIO MANDRINO**



1.050⁰⁰ €
+ IVA



**DCH333X2-QW
TASSELLATORE SDS-PLUS 30MM
3.5J XR FV 9AH**



955⁰⁰ €
+ IVA



**DCH323T2-QW
TASSELLATORE SDS-PLUS 28MM
2.8J XR FV 6AH**



DCG418X2-QW
820⁰⁰ €
+ IVA

DCG418T2-QW
713⁰⁰ €
+ IVA



**SMERIGLIATRICE ANGOLARE 125MM
DCG418X2-QW XR FV 9AH
DCG418T2-QW XR FV 6AH**



840⁰⁰ €
+ IVA



**DCD240X2-QW
MISCELATORE A DOPPIA
IMPUGNATURA XR FV 9AH**



795⁰⁰ €
+ IVA



**DCG200T2-QW
SCANALATRICE 125MM
XR FV 6AH**



**WIRELESS
TOOL CONTROL™**

1.060⁰⁰ €
+ IVA

POSSIBILITÀ DI ALLOGGIARE
LE BATTERIE XR FLEXVOLT
15AH (DCB549-X.J)



**DCS691X2-QW
TRONCATORE 230MM
XR FV 9AH**



940⁰⁰ €
+ IVA

**DCS398T2-QW
SEGA ALLIGATOR 430MM
XR FV 6AH**



DCS389X2-QW
825⁰⁰ €
+ IVA

DCS389T2-QW
720⁰⁰ €
+ IVA



**SEGA UNIVERSALE
DCS389X2-QW XR FV 9AH
DCS389T2-QW XR FV 6AH**



DCS579X2-QW
880⁰⁰ €
+ IVA

DCS579T2-QW
780⁰⁰ €
+ IVA



**SEGA CIRCOLARE Ø 190MM
DCS579X2-QW XR FV 9AH
DCS579T2-QW XR FV 6AH**



750⁰⁰ €
+ IVA



**DCV586MT2-QW
ASPIRATORE CLASSE M
XR FV 6AH**

BATTERIE E CARICABATTERIE

DCB094K-QW ADATTATORE CARICABATTERIE USB 18V

- Collegato alla batteria alimenta dispositivi elettronici tramite cavo USB
- Collegato all'alimentatore in dotazione ha funzione di caricabatteria (carica una batteria 18V 5Ah in 65 min.)
- Doppia porta USB (1 type A e 1 type C)

DOTAZIONE: Cavo USB PD lunghezza 1 mt, alimentatore USB C 100W, gancio da cintura

135^{.00} €
+ IVA



XR FLEX VOLT

209^{.00} €
+ IVA



DCB547G-XJ
BATTERIA 54V XR FV 9AH
Serie G resistente a oli e solventi

XR FLEX VOLT

400^{.00} €
+ IVA



DCB549-XJ
BATTERIA XR FV 15AH
Compatibile con elettroutensili XR e XR FV

POWERSTACK

99^{.00} €
+ IVA



NOVITÀ

DCBP034G-XJ
BATTERIA POWERSTACK 18V
Serie G resistente a oli e solventi

54V XR FLEX VOLT
18V XR

125^{.00} €
+ IVA



DCB117-QW
CARICABATTERIE RAPIDO
18V-54V 12A

245^{.00} €
+ IVA



DCB104-QW
CARICABATTERIE RAPIDO
UNIVERSALE A 4 INGRESSI

115^{.00} €
+ IVA



DCB184G-XJ
BATTERIA 18V XR 5AH
Serie G resistente a oli e solventi

79^{.00} €
+ IVA



DCB183G-XJ
BATTERIA 18V XR 2AH
Serie G resistente a oli e solventi

91^{.00} €
+ IVA



DCB126G-XJ
BATTERIA 12V XR 5AH
Serie G resistente a oli e solventi

75^{.00} €
+ IVA



DCB124G-XJ
BATTERIA 12V XR 3AH
Serie G resistente a oli e solventi

54V XR FLEX VOLT

Scegli il tuo
STARTER KIT

XR FLEX VOLT
6AH
379⁰⁰ €
+ IVA



DCB118T2-QW
STARTER KIT 54V 6AH
• 2 batterie XR FV 6 Ah
• 1 caricabatterie rapido output 8A

XR FLEX VOLT
9AH
479⁰⁰ €
+ IVA



DCB118X2-QW
STARTER KIT 54V 9AH
• 2 batterie XR FV 9 Ah
• 1 caricabatterie rapido output 8A

XR FLEX VOLT
12AH
600⁰⁰ €
+ IVA



DCB118Y2-QW
STARTER KIT 54V 12AH
• 2 batterie XR FV 12 Ah
• 1 caricabatterie rapido output 8A

54V XR FLEX VOLT

Se vuoi completare
la tua attrezzatura
scegli:

**IL CORPO
MACCHINA
CHE FA PER TE**

750⁰⁰ €
+ IVA

**DCH892N-XJ MARTELLLO
DEMOLITORE SDS-MAX
19.4J XR FV 9AH**

529⁰⁰ €
+ IVA

**DCH832N-QW MARTELLLO
DEMOLITORE SDS-MAX
10.5J XR FV 9AH**

960⁰⁰ €
+ IVA

**DCH775N-XJ MARTELLLO
DEMOPERFORATORE SDS-
MAX 52MM 19.4J**

865⁰⁰ €
+ IVA

**DCH735N-XJ MARTELLLO
DEMOPERFORATORE
SDS-MAX 48MM 13.3J**

765⁰⁰ €
+ IVA

**DCH614N-XJ MARTELLLO
DEMOPERFORATORE
SDS-MAX 45MM 10.5J**

685⁰⁰ €
+ IVA

**DCH481N-XJ MARTELLLO
DEMOPERFORATORE
SDS-MAX 40MM 6.1J**

739⁰⁰ €
+ IVA

**DCH417NT-XJ
TASSELLATORE
SDS-PLUS 32MM 4.5J**

635⁰⁰ €
+ IVA

**DCH333NT-XJ
TASSELLATORE SDS-PLUS
30MM 3.5J**

595⁰⁰ €
+ IVA

**DCH323NT-XJ
TASSELLATORE SDS-PLUS
28MM 2.8J**

SOLUZIONE **XR 54V** CHE FA PER TE



440^{.00} €
+ IVA

DCG440N-XJ
SMERIGLIATRICE
ANGOLARE 180MM



435^{.00} €
+ IVA

DCG418NT-XJ
SMERIGLIATRICE
ANGOLARE 125MM



475^{.00} €
+ IVA

DCG200NT-XJ
SCANALATRICE 125MM



590^{.00} €
+ IVA

DCS691N-XJ
TRONCATORE 230MM

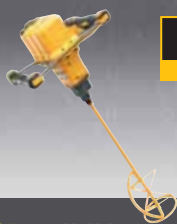

460^{.00} €
+ IVA

DCD240N-XJ
MISCELATORE A DOPPIA
IMPUGNATURA



435^{.00} €
+ IVA

DCS389NT-XJ
SEGA UNIVERSALE



530^{.00} €
+ IVA

DCS397N-XJ
SEGA ALLIGATOR 430MM



475^{.00} €
+ IVA

DCS579NT-XJ
SEGA CIRCOLARE
Ø 190MM



645^{.00} €
+ IVA

DCS777N-XJ
TRONCATRICE RADIALE
216MM



815^{.00} €
+ IVA

DCS727N-XJ
TRONCATRICE RADIALE
250MM

NOVITÀ



1.059^{.00} €
+ IVA

DCS781N-XJ
TRONCATRICE RADIALE
305MM



480^{.00} €
+ IVA

DCC1054N-XJ
COMPRESSORE 10 LITRI

All'acquisto dello
starter kit e di un
corpo macchina

**IN
DOTAZIONE
A TUA SCELTA**

OPPURE



**CARICABATTERIA
RAPIDO XR 12A
DCB117-QW**

OPPURE



**VASCA FONDA
CON RUOTE TSTAK
DWST83347-1**



**BATTERIA
XR FLEXVOLT 6.0AH
DCB546-XJ**

**POWER
STACK**™
BATTERY TECHNOLOGY

THE
NEXT DIMENSION
IN POWER™



POWERSTACK 18V

è la prima batteria al mondo, per
elettroutensili, ad usare la tecnologia
delle celle a sacchetto (Pouch Cell).
Mai vista una batteria così!



50%*
PIÙ POTENTE

+

2x*
DURATA DELLA
VITA UTILE

+



La batteria compatta POWERSTACK è compatibile con tutta la gamma di oltre 250 elettroutensili DEWALT XR 18V



SCEGLI LA TUA **POWERSTACK**



COMPATTEZZA

25%*
PIÙ COMPATTA



DCBP034-XJ BATTERIA 18V COMPATTA POWERSTACK

Design compatto e leggero.
Scocca gommata, indicatore di carica a LED, peso 0,32 Kg.

AUTONOMIA

50%*
DI LAVORO IN
PIÙ PER CARICA



NEW
5AH

DCBP518-XJ BATTERIA 18V 5AH POWERSTACK

Consente di lavorare col 50% in più di autonomia.
Scocca gommata, indicatore di carica a LED, peso 0,68 Kg.

* 50% PIÙ POTENTE, 2X DURATA VITA UTILE, 25% PIÙ COMPATTA: DCBP034 rispetto DBC183. 50% DI LAVORO IN PIÙ PER CARICA: energia utilizzabile batteria DCBP518 rispetto alle batterie DEWALT XR® 5Ah o inferiori non in applicazione.

QUALE POTENZA TI SERVE?

12V XR

18V XR

POWERSTACK

54V XR FLEX VOLT

349^{.00} €
+ IVA



PIU' COMPATTEZZA

DCD805E2T-QW
TRAPANO AVVITATORE
CON PERCUSSIONE
18V **POWERSTACK**

- Potenza 90Nm
- 2 velocità
- Peso 1,2 kg

DOTAZIONE: 2 batterie 18V **POWERSTACK**, caricabatterie 2A, valigetta TSTAK

489^{.00} €
+ IVA



PIU' AUTONOMIA

DCD805H2T-QW
TRAPANO AVVITATORE
CON PERCUSSIONE 18V
POWERSTACK 5AH

- Potenza 90Nm
- 2 velocità
- Peso 1,2 kg

DOTAZIONE: 2 batterie 18V **POWERSTACK 5Ah**, caricabatterie 4A, valigetta TSTAK

599^{.00} €
+ IVA



PIU' POTENZA

DCD999H2T-QW
TRAPANO AVVITATORE
CON PERCUSSIONE XRP
18V **POWERSTACK 5AH**

- Max coppia 112Nm
- 3 velocità 0-450/1300/2000 giri/min
- Peso 1,61 kg

DOTAZIONE: 2 batterie 18V **POWERSTACK 5Ah**, caricabatterie 4A, valigetta TSTAK

DCBP518-XJ
BATTERIA 18V **POWERSTACK**

Batteria 5Ah con tecnologia delle celle a sacchetto che consente di lavorare col 50% in più di autonomia. Scocca gommata per una maggiore resistenza agli urti e una lunga durata. Indicatore di carica LED. Peso 0.68 kg

169^{.00} €
+ IVA

POWERSTACK™





550⁰⁰ €
+ IVA



DCF921H2T-QW
AVVITATORE A IMPULSI 1/2"
4 MODALITÀ (PONTEGGIO)
406NM 18V POWERSTACK 5AH

- 0-3550 impulsi/min
- 2 velocità: 0-1400-2500 giri/min
- Max Ø bullone M20
- 3 luci led
- Peso 1.1 kg*

DOTAZIONE: 2 batterie 18V **POWERSTACK 5AH**, caricabatterie 4A, TSTAK



575⁰⁰ €
+ IVA



DCF891H2T-QW
AVVITATORE A IMPULSI 1/2"
4 MODALITÀ 812NM
18V POWERSTACK 5AH

- 0-3250 impulsi/min
- 0- velocità: 0-2000 giri/min
- Max Ø bullone M24
- 3 luci led
- Peso 1.7 kg*

DOTAZIONE: 2 batterie 18V **POWERSTACK 5AH**, caricabatterie 4A, TSTAK



599⁰⁰ €
+ IVA



DCF900H2T-QW
AVVITATORE A IMPULSI 1/2"
4 MODALITÀ 1355 NM
18V POWERSTACK 5AH

- 0-2200 impulsi/min
- 3 velocità 0-650-1250-2300 giri/min
- Max Ø bullone M30
- Luce led
- Peso 2.9 kg*

DOTAZIONE: 2 batterie 18V **POWERSTACK 5AH**, caricabatterie 4A, TSTAK



599⁰⁰ €
+ IVA



DCH273H2T-QW
TASSELLATORE SDS-PLUS 2.1 J
18V POWERSTACK 5AH

- 3 Modalità
- Max Ø 24mm
- Energia del colpo 2.1J (EPTA 05/2009)
- Percussioni/min 4600

DOTAZIONE: 2 batterie 18V **POWERSTACK 5AH**, caricabatterie 4A, TSTAK

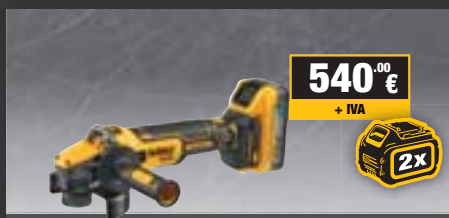

540⁰⁰ €
+ IVA



DCG409H2T-QW
SMERIGLIATRICE 125MM
18V POWERSTACK 5AH

- Velocità 9000 giri/min
- Freno motore elettronico anti "Kick Back"
- Frizione elettronica
- Impugnatura gommata

DOTAZIONE: 2 batterie 18V **POWERSTACK 5AH**, caricabatteria 4A, TSTAK

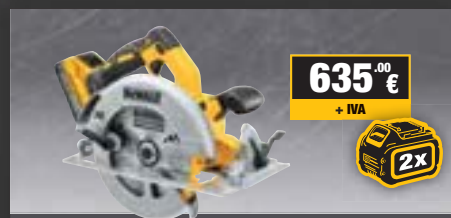

635⁰⁰ €
+ IVA



DCS570H2T-QW
SEGA CIRCOLARE 184MM
18V POWERSTACK 5AH

- Velocità 5500 giri/min
- Max profondità taglio 90°/45° 65/45mm
- Max inclinazione lama fino a 57°

DOTAZIONE: 2 batterie 18V **POWERSTACK 5AH**, caricabatteria 4A, TSTAK

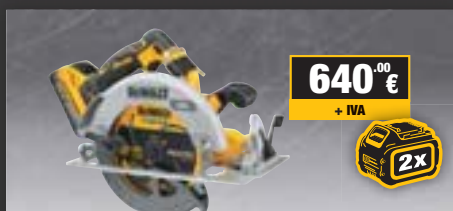

640⁰⁰ €
+ IVA



DCS573H2T-QW
SEGA CIRCOLARE 190MM
18V POWERSTACK 5AH

- Velocità 5.500 giri/minuto
- Max profondità taglio 90°/45° 67/51mm
- Max inclinazione lama fino a 57°
- Freno elettronico
- Luce LED

DOTAZIONE: 2 batterie 18V **POWERSTACK 5AH**, caricabatteria 4A, TSTAK



590⁰⁰ €
+ IVA



DCS386H2T-QW
SEGA UNIVERSALE
18V POWERSTACK 5AH

- Corse/min: 0-3.000
- Lunghezza corsa 28.6mm
- Aggancio rapido della lama
- Luce LED

DOTAZIONE: 2 batterie 18V **POWERSTACK 5AH**, caricabatteria 4A, TSTAK



665⁰⁰ €
+ IVA



DCS367H2T-QW
SEGA UNIVERSALE COMPATTA
18V POWERSTACK 5AH

- Corse/Min: 0-2900
- Lunghezza corsa 28.6 mm
- Aggancio rapido della lama
- Luce LED

DOTAZIONE: 2 batterie 18V **POWERSTACK 5AH**, caricabatteria 4A, TSTAK

DCBP034-XJ
BATTERIA 18V
POWERSTACK
(con celle a sacchetto)

Design compatto e leggero, scocca gommata per una maggior resistenza agli urti e una lunga durata, indicatore di carica a LED, peso 0,32 kg.

99^{.00} €
 + IVA

POWERSTACK™



408^{.00} €
 + IVA



DCH172E2T-QW TASSELLATORE SDS-PLUS
2 MODALITÀ 18V POWERSTACK

- Potenza colpo (EPTA 05/2009) 1.4J
- Max Ø foratura 16mm
- Percussioni/min 0-4980
- Peso 2.1 kg*

DOTAZIONE: 2 batterie 18V **POWERSTACK**, caricabatterie, valigetta TSTAK

349^{.00} €
 + IVA



DCD805E2T-QW TRAPANO AVVITATORE
CON PERCUSSIONE 18V POWERSTACK

- Potenza 90Nm
- Peso 1,2 kg*

DOTAZIONE: 2 batterie 18V **POWERSTACK**, caricabatterie, valigetta TSTAK

329^{.00} €
 + IVA



DCD800E2T-QW TRAPANO AVVITATORE 18V
POWERSTACK

- Potenza 90Nm
- Peso 1,2 kg*

DOTAZIONE: 2 batterie 18V **POWERSTACK**, caricabatterie, valigetta TSTAK

455^{.00} €
 + IVA



DCS438E2T-QW MINITRONCATRICE

- Velocità 20.000 giri/min
- Ø disco/foro 76/10mm
- Max profondità taglio 22mm
- Peso 0.94 kg*

DOTAZIONE: 2 batterie 18V **POWERSTACK**, cuffia aspirazione, disco abrasivo, disco diamantato piastrelle, disco diamantato multimaterial, caricabatteria, valigetta TSTAK

* Il peso indicato è riferito al solo corpo macchina

GAMMA

250+ 18V XR

PARTE DEL SISTEMA 18V XR



359.⁰⁰ €

+ IVA

2x

206NM

1/4"

DCF850E2T-QW AVVITATORE A IMPULSI 1/4" 3 VELOCITÀ 206NM 18V POWERSTACK

- 0-3800 impulsi/min
- Max ø bullone M16 - 3 luci led
- Peso 0.9 kg*

DOTAZIONE: 2 batterie 18V POWERSTACK, caricabatterie, valigetta TSTAK



430.⁰⁰ €

+ IVA

2x

406NM

610NM

1/2"

**PRECISION
WRENCH**

DCF921E2T-QW AVVITATORE A IMPULSI 1/2" 4 MODALITÀ (PONTEGGIO) 406NM 18V POWERSTACK

- 0-3550 impulsi/min
- 3 luci led
- Peso 1.1 kg*

DOTAZIONE: 2 batterie 18V POWERSTACK, caricabatterie, valigetta TSTAK

KIT 18V POWERSTACK DCK2052H1E1T-QW

- DCD999 Trapano a percussione 3 velocità 112Nm
- DCF850 Avvitatore impulsi 1/4" 206Nm
- 1 batteria 18V POWERSTACK 5Ah
- 1 batteria 18V POWERSTACK compatta
- Caricabatterie 4A
- Valigetta TSTAK

695.⁰⁰ €

+ IVA

2x



NOVITÀ



585.⁰⁰ €

+ IVA

2x

KIT 18V POWERSTACK DCK2050E2T-QW

- DCD805 Trapano a percussione 90Nm
- DCF850 Avvitatore impulsi 1/4" 206Nm
- 2 Batterie 18V POWERSTACK
- Caricabatterie
- Valigetta TSTAK

* Il peso indicato è riferito al solo corpo macchina

DCG409VSNT-XJ SMERIGLIATRICE ANGOLARE 125MM BRUSHLESS VELOCITÀ VARIABILE

- 6 Velocità regolabili da 3000 a 9000 giri/min
- Protezione da sovraccarico
- Freno motore elettronico
- Anti «Kick Back»
- Frizione Elettronica
- Peso 1.8 kg*

DOTAZIONE:
Impugnatura laterale
Protezioni per sbavo e taglio
Chiave di servizio
Valigetta TSTAK



250⁰⁰ €
+ IVA

WIRELESS
TOOL CONTROL

NOVITÀ

DCS496N-XJ CESOIA PER TAGLI CURVI E LAMIERE ONDULATE

- Testa orientabile 360°
- Max capacità di taglio 1.3mm
- Minimo raggio di curvatura 25.4 mm
- Interruttore a velocità variabile
- Luce Led
- Peso 1.5 kg*

In scatola di cartone



295⁰⁰ €
+ IVA

NOVITÀ

DCD800P2T-QW TRAPANO AVVITATORE BRUSHLESS 18V XR 5AH

- Potenza 90Nm
- Velocità 0-650/2.000 giri/min

DOTAZIONE:
2 batterie 18V XR 5Ah,
caricabatteria, TSTAK

DCD805P2T-QW TRAPANO AVVITATORE A PERCUSSIONE BRUSHLESS 18V XR 5AH

- Potenza 90Nm
- Velocità 0-650/2.000 giri/min
- Percussioni 0-34.000/minuto

DOTAZIONE:
2 batterie 18V XR 5Ah,
caricabatteria, TSTAK



DCD800P2T-QW

DCD805P2T-QW

359⁰⁰ €
+ IVA

379⁰⁰ €
+ IVA



DCD708D2T-QW TRAPANO AVVITATORE BRUSHLESS 18V XR 2AH

DCD709D2T-QW TRAPANO AVVITATORE A PERCUSSIONE BRUSHLESS 18V XR 2AH



DCD708D2T-QW

DCD709D2T-QW

205⁰⁰ €
+ IVA

225⁰⁰ €
+ IVA



SERIE COMPACT

**MANDRINO
IN METALLO!**



DCD1623X2G-QW TRAPANO A SUPPORTO MAGNETICO 18V BL

- 2 velocità meccaniche con regolazione elettronica 130-420/250-810 giri/min
- Doppio senso di rotazione
- Attacco Weldon 19mm
- Max diametro di foratura 50mm
- Max profondità di taglio 50mm
- Sistema di sicurezza Antirotazione
- Magnete permanente regolabile in 3 posizioni
- Peso 14.3 kg
- Altezza 345.4 mm
- Illuminazione a led

2.199⁰⁰ €
+ IVA



DOTAZIONE:
mandrino a cremagliera
std 13mm, serbatoio
per lubrificante,
catena di sicurezza,
2 batterie FV 9Ah G,
caricabatteria,
valigetta

**PERFORM
PROTECT**





DCG405P2-QW SMERIGLIATRICE 125MM BRUSHLESS 18V XR 5 AH

- Velocità a vuoto 9000 giri/min
- Interruttore a slitta
- Vibrazioni 4.4 m/s²
- Peso 2.6 kg

DOTAZIONE: 2 batterie XR 5Ah, caricabatterie, valigetta TSTAK

340.⁰⁰ €
+ IVA



432.⁰⁰ €
+ IVA



DCH172P2-QW TASSELLATORE SDS-PLUS 1.4J 18V XR 5 AH

- 2 Modalità
- Max Ø16 mm
- Energia del colpo 1.4J (EPTA 05/2009)
- Percussioni/min 4980

DOTAZIONE: 2 batterie XR 5Ah, caricabatterie, valigetta TSTAK

DCH273P2T-QW TASSELLATORE SDS-PLUS 2.1J 18V XR 5 AH

- 3 Modalità
- Max Ø 24mm
- Energia del colpo 2.1J (EPTA 05/2009)
- Percussioni/min 4600

DOTAZIONE: 2 batterie XR 5Ah, caricabatterie, valigetta TSTAK

489.⁰⁰ €
+ IVA



559.⁰⁰ €
+ IVA



DCH274P2T-QW TASSELLATORE SDS-PLUS 2.1J 18V XR 5 AH DOPPIO MANDRINO

- 3 Modalità
- Max Ø 24mm
- Energia del colpo 2.1J (EPTA 05/2009)
- Percussioni/min 4600

DOTAZIONE: mandrino autoserrante
2 batterie XR 5Ah, caricabatterie,
valigetta TSTAK

LE ABBINATE XR 18V DeWALT

1.135⁰⁰ €
+ IVA

18V XR

KIT 18V XR 5AH DCK353P4T-IT

- DCH273 Tassellatore SDS-Plus
- DCD796 Trapano a percussione
- DCG405 Smerigliatrice 125mm
- 4 Batterie XR 18V 5AH
- 2 Caricabatterie
- 3 Valigette TSTAK



KIT 18V XR 5AH DCK2153P2T-IT

- DCD796 Trapano a percussione
- DCG405 Smerigliatrice 125mm
- 2 Batterie XR 18V 5AH
- Caricabatterie rapido
- 2 Valigette TSTAK

580⁰⁰ €
+ IVA

18V XR



609⁰⁰ €
+ IVA

18V XR

KIT 18V XR 5AH DCK922HDP2-IT

- DCF922 Avvitatore impulsivi 812NM
- DCD805 Trapano a percussione
- 2 Batterie XR 18V 5AH
- Caricabatterie rapido
- 2 Valigette TSTAK



AVVITATORI A IMPULSI

DCF840D2T-QW AVVITATORE A IMPULSI 1/4" 192NM 18V XR 2AH

- 0-3200 impulsi/min
- Max ø bullone M14
- 3 luci led
- Peso 0.9Kg*

DOTAZIONE:
2 batterie 18V XR
2Ah, caricabatterie,
valigetta TSTAK



DCF850P2T-QW AVVITATORE A IMPULSI 1/4" 3 VELOCITÀ 206NM 18V XR 5AH

- 0-3800 impulsi/min
- Max ø bullone M16
- 3 luci led
- Peso 0.9Kg*

DOTAZIONE:
2 batterie 18V XR 5Ah,
caricabatterie,
valigetta TSTAK



DCF922P2T-QW AVVITATORE A IMPULSI 1/2" 4 MODALITÀ (VITI) 406NM 18V XR 5AH

- 0-3550 impulsi/min
- 3 luci led
- Peso 1.1Kg*

DOTAZIONE:
2 batterie 18V XR 5Ah,
caricabatterie,
valigetta TSTAK



DCF891P2T-QW AVVITATORE A IMPULSI 1/2" 812NM 18V XR 5AH

- 0-3250 impulsi/min
- 3 luci led
- 4 modalità
- Peso 1.7Kg*

DOTAZIONE:
2 batterie 18V XR
5Ah, caricabatterie,
valigetta TSTAK



DCF900P2T-QW AVVITATORE A IMPULSI 1/2" 18V XR BRUSHLESS

- 4 modalità
- 3 velocità: 0-650/135Nm,
0-1250/813Nm, 0-2300/1355Nm
- Svitatura 1898Nm
- Max Ø bullone M30
- Colpi al minuto 0-2200
- Peso 2.9 kg (solo corpo macchina)

DOTAZIONE:
2 batterie 18V XR 5Ah, caricabatterie,
valigetta TSTAK



**PRECISION
WRENCH**

**18V
XR**

**PERFORM
PROTECT**



18V XR

DCF897X2-IT
AVVITATORE AD IMPULSI
3/4" 18V XR FV 9AH

- Attacco 3/4"
- Velocità (giri/min)
0-400 / 1200 / 1900
- Max Ø bullone M20

DOTAZIONE:
 2 batterie XR FV 9AH,
 caricabatterie, valigetta
 TSTAK VI fondo

2x **835.⁰⁰ €**
 + IVA



950NM
 1826NM

DCF900P2G-QW
AVVITATORE AD IMPULSI
1/2" 18V XR 5AH

- Attacco 1/2"
- Coppia 135/813/1355 Nm
- Colpi al minuto 0-2200
- 3 velocità (giri/min)
0-650 / 1250 / 2300
- Max Ø bullone M30

DOTAZIONE: 2 batterie 18V XR
 "G" 5Ah, caricabatteria, schiuma
 preformata per cassettera,
 sovrascocca in gomma

2x **499.⁰⁰ €**
 + IVA



1355NM
 1898NM

DCF891P2G-QW
AVVITATORE AD IMPULSI
1/2" 812NM 18V XR
5AH CON BATTERIE "G"

- Attacco 1/2" HOG RING
- Colpi/min 0-3550
- Max Ø bullone M24

DOTAZIONE: 2 batterie 18V XR
 "G" 5Ah, caricabatteria,
 schiuma preformata per
 cassettera, sovrascocca
 in gomma

2x **475.⁰⁰ €**
 + IVA



812NM
 1894NM

18V XR

DCF901P1G-QW
AVVITATORE AD IMPULSI
1/2" 340NM 12V XR
5AH CON BATTERIE "G"

- Attacco 1/2"
- Max Ø bullone M16

DOTAZIONE: 1 batteria 12V XR
 "G" 5Ah, caricabatteria,
 schiuma preformata
 per cassettera,
 sovrascocca in gomma

1x **290.⁰⁰ €**
 + IVA



340NM
 500NM

12V XR

DCF903P1G-QW
AVVITATORE AD IMPULSI
3/8" 340NM 12V XR
5AH CON BATTERIE "G"

- Attacco 3/8"
- Max Ø bullone M16

DOTAZIONE: 1 batteria 12V XR
 "G" 5Ah, caricabatteria,
 schiuma preformata
 per cassettera,
 sovrascocca in gomma

1x **290.⁰⁰ €**
 + IVA



340NM
 500NM

12V XR

AVVITATORI AD IMPULSI SERIE "G"

dedicati al settore Automotive / Industria



AVVITATORI AD IMPULSI
DCF901P1G **DCF891P2G**
DCF903P1G **DCF900P2G**
dotazione dotazione
1 batteria 2 batterie
XR 12V "G" 5Ah XR 12V "G" 5Ah



STIVALE IN GOMMA
evita danneggiamento del materiale su cui operi e preserva l'utensile in caso di cadute o contatto diretto con olii/solventi



BATTERIE XR 12V E XR 18V SERIE "G"
scocca in GFN (Glass-Filled Nylon) resistente alla maggior parte di olii e solventi. Maggiore resistenza a colpi e cadute. Gommatura esterna per preservare le superfici su cui si lavora



SCHIUMA PREFORMATA PER CASSETTIERE
schiuma con scomparti per avvitatore impulsivi e batterie da riporre all'interno dei cassettei dei carrelli (modulare carrelli USAG e Facom)

STIVALI IN GOMMA PER AVVITATORI AD IMPULSI

Evita danneggiamento del materiale su cui operi e preserva l'utensile in caso di cadute o contatto diretto con olii/solventi

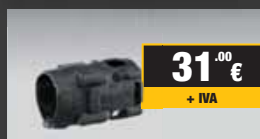

31^{.00} €
+ IVA

PB900.899-QZ

- idoneo per DCF900

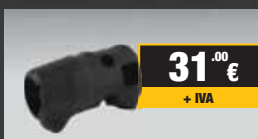

31^{.00} €
+ IVA

PB891.92-QZ

- idoneo per DCF891



27^{.00} €
+ IVA

PB901.03-QZ

- idoneo per DCF901/DCF903



27^{.00} €
+ IVA

PB850-QZ

- idoneo per DCF850

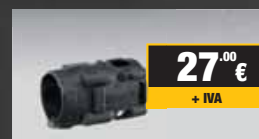

27^{.00} €
+ IVA

PB921.22.23-QZ

- idoneo per DCF921/DCF922

SISTEMA MODULARE AD ANGOLO

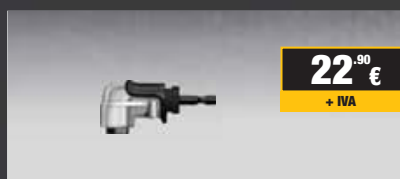

22^{.90} €
+ IVA

DT20503-QZ TESTA AD ANGOLO ULTRA COMPATTA

- Attacco 1/4" magnetico
- Coppia massima 43Nm



26^{.50} €
+ IVA

DT20500-QZ TESTA AD ANGOLO CON IMPUGNATURA

- Attacco 1/4" magnetico
- Coppia massima 43Nm



39^{.50} €
+ IVA

DT20501-QZ TESTA AD ANGOLO CON IMPUGNATURA ED ALBERO FLESSIBILE

- Attacco 1/4" magnetico
- Coppia massima 43Nm

ACCESSORI AVVITATORI A IMPULSI



DT50050-QZ
68^{.00} €
+ IVA

10 PEZZI

SET FORARE METALLO

- Punta Titanium metallo attacco 1/4" Ø: 3, 3.2, 3.5, 4, 4.5, 5, 6, 8, 10, 12mm



DT70523T-QZ
22^{.50} €
+ IVA

32 PEZZI

SET AVVITARE

- Inserti 25mm: PH1, 2, 3 - PZ1, 2, 3 - SL6, 8 - T10, 15, 20, 25, 27, 30, 40 Porta inserti magnetico



EXTREME

Codici disponibili a Listino pag. 124

Lunghezza 38mm



RESISTENZA 700Nm

Lunghezza 78mm



BUSSOLE A TESTA ESAGONALE ATTACCO 1/2"

- Lunghezza 38mm Ø: 12, 13, 14, 15, 16, 17, 18, 19, 21, 22, 24mm
- Lunghezza 78mm Ø: 17, 18, 19, 21, 22, 24mm



12V / 18V

200^{.00} €
+ IVA



DCL045-XJ

LAMPADA SOTTOCOFANO 12/18V XR

- Compatibilità batterie XR 12V e 18V
- LED azionabili separatamente
- Ganci ruotabili
- Temperatura colore: 5000K
- Funzionamento con batteria 12/18V XR
- Luminosità: 800/1650 Lm
- Pieghevole
- Lunghezza utile 1.3-1.9 mt

Versione in scatola di cartone senza batterie e caricabatteria

18V XR

465^{.00} €
+ IVA



18V XR

465^{.00} €
+ IVA



DCM849P2-QW

LUCIDATRICE ROTATORIA 180MM 18V XR 5AH

- Motore BRUSHLESS
- Velocità 800 - 2000 opm
- Ø max platorello 180mm

DOTAZIONE: 2 batterie XR 18V 5Ah, caricabatterie, platorello in gomma da 180mm, impugnatura laterale dritta, Soft bag

DCM848P2-QW

LUCIDATRICE ROTO ORBITALE 125MM 18V XR 5AH

- Motore BRUSHLESS
- Orbita 15mm
- Velocità 2000 - 5500 opm
- Ø max platorello 125mm

DOTAZIONE: 2 batterie XR 18V 5Ah, caricabatterie, platorello in gomma da 125mm, impugnatura laterale dritta, Soft bag

235^{.00} €
+ IVA



DWP849X-QS

LUCIDATRICE 1250W

- Diametro 150-180mm
- Velocità variabile 0-600 / 3500 giri/min
- Filetto albero M14

DOTAZIONE: platorello in gomma da 180mm con attacco in velcro, tampone di lana 180mm con velcro, impugnatura laterale dritta, impugnatura a D

81^{.00} €
+ IVA



DWD014S-QS

TRAPANO ROTATIVO 550W

- Velocità 0-2800 giri/min
- Coppia 7.9Nm
- Mandrino autoserrante 1.0-10mm

NUOVA GAMMA CRICCHETTI BRUSHLESS

Nuova gamma di cricchetti disponibile nelle versioni XR 12V o 18V con attacchi 1/4" 1/2" 3/8" e differenti lunghezze della testa. Potenti, leggeri e compatti, grazie alla forma in linea e alla testa ribassata (23 o 30mm) sono ideali per avviature in spazi ristretti.

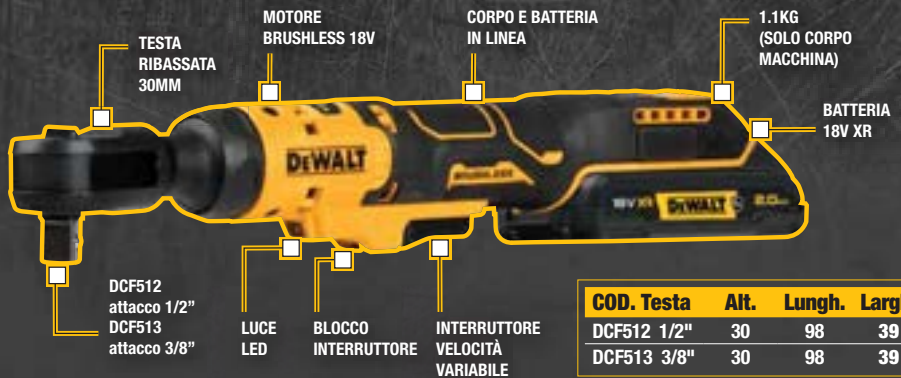

COD. Testa	Alt.	Lungh.	Largh.
DCF512 1/2"	30	98	39
DCF513 3/8"	30	98	39



285⁰⁰ €
+ IVA

12"

DCF512D1-QW CRICCHETTO ATTACCO 1/2" 18V XR

Dotazione: 1 batteria XR 18V 2Ah, caricabatteria, borsa in cordura



DCF512D1G-QW
285⁰⁰ €
+ IVA

12"

DCF513D1G-QW
285⁰⁰ €
+ IVA

38"

DCF512D1G-QW / DCF513D1G-QW CRICCHETTO 18V XR serie "G"

Dotazione: 1 batteria XR 18V 2Ah serie G, caricabatteria, schiuma preformata per cassettiere

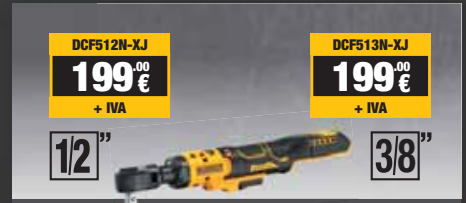

DCF512N-XJ
199⁰⁰ €
+ IVA

12"

DCF513N-XJ
199⁰⁰ €
+ IVA

38"

DCF512N-XJ / DCF513N-XJ CRICCHETTO 18V XR

Senza batterie e caricabatteria in scatola di cartone

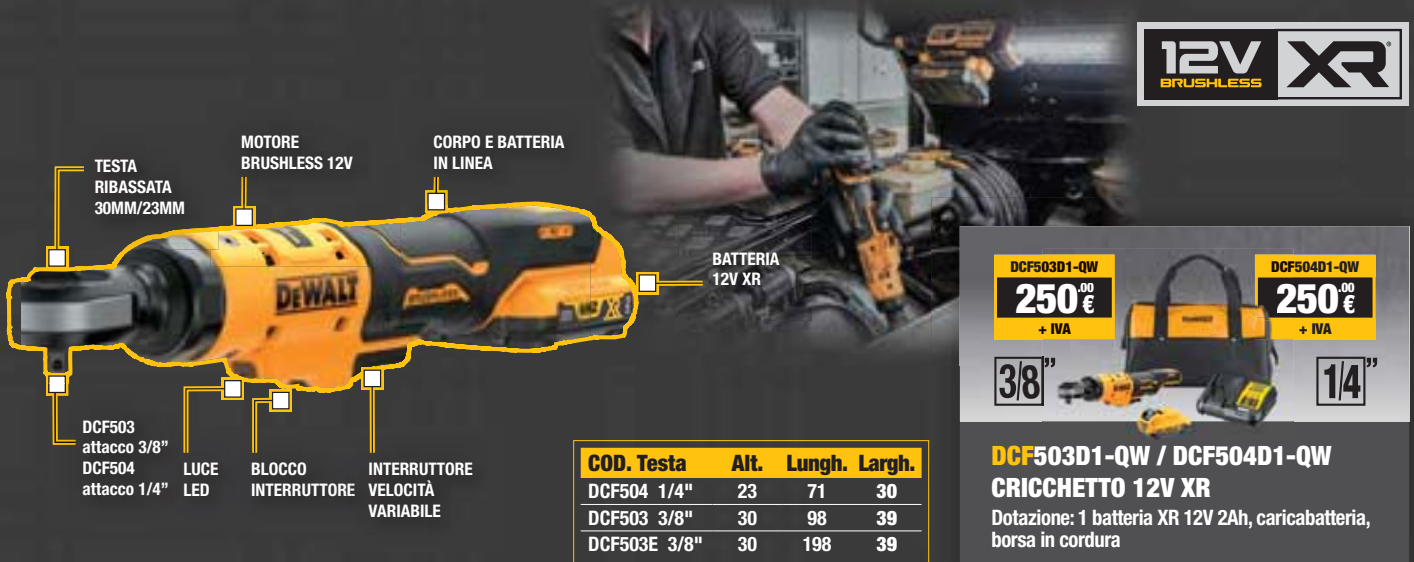

12V
BRUSHLESS XR

COD. Testa	Alt.	Lungh.	Largh.
DCF504 1/4"	23	71	30
DCF503 3/8"	30	98	39
DCF503E 3/8"	30	198	39

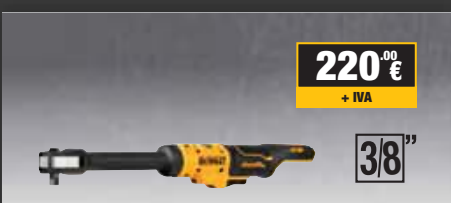

220⁰⁰ €
+ IVA

3/8"

DCF503EN-XJ CRICCHETTO ATTACCO 3/8" 12V XR

TESTA LUNGA Senza batterie e caricabatteria in scatola di cartone



DCF503L1G-QW
290⁰⁰ €
+ IVA

3/8"

DCF504L1G-QW
290⁰⁰ €
+ IVA

14"

DCF503L1G-QW / DCF504L1G-QW CRICCHETTO 12V XR serie "G"

Dotazione: 1 batteria XR 12V 3Ah serie "G", caricabatteria, schiuma preformata per cassettiere

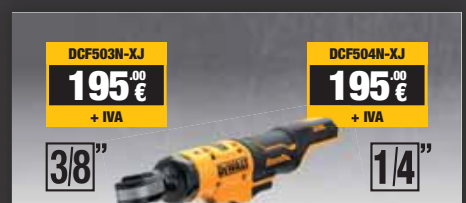

DCF503N-XJ
195⁰⁰ €
+ IVA

3/8"

DCF504N-XJ
195⁰⁰ €
+ IVA

14"

DCF503N-XJ / DCF504N-XJ CRICCHETTO 12V XR

Senza batterie e caricabatteria in scatola di cartone

SCEGLI LA SOLUZIONE 18V XR CHE FA PER TE

18V XR
BRUSHLESS



STARTER KIT

Composti da:
Caricabatteria +
Batterie 18V XR

DCB1104H2-QW
BATTERIA 18V XR
5.0AH **POWERSTAK**

359⁰⁰ €
+ IVA



DCB1102E2-QW
BATTERIA 18V XR
POWERSTAK

199⁰⁰ €
+ IVA



DCB1104P3-QW
BATTERIA 18V
XR 5.0AH

275⁰⁰ €
+ IVA



DCB1104D2-QW
BATTERIA 18V
XR 2.0AH

145⁰⁰ €
+ IVA



Se vuoi completare
la tua attrezzatura
scegli:

IL CORPO MACCHINA CHE FA PER TE

230⁰⁰ €
+ IVA



DCG409NT-XJ
SMERIGLIATRICE 125MM
potenza resa 1553W

NOVITÀ

250⁰⁰ €
+ IVA



DCG409VSNT-XJ
SMERIGLIATRICE ANGOLARE 125MM
BRUSHLESS VELOCITÀ VARIABILE



196⁰⁰ €
+ IVA

DCG405NT-XJ
SMERIGLIATRICE ANGOLARE 125MM
potenza resa 800W



246⁰⁰ €
+ IVA

DCG405FNT-XJ
SMERIGLIATRICE ANGOLARE 125MM
A TESTA PIATTA



240⁰⁰ €
+ IVA

DCS438N-XJ
MINITRONCATRICE BRUSHLESS*
76MM



379⁰⁰ €
+ IVA

DCS573NT-XJ
SEGA CIRCOLARE 190MM
18V XR



292⁰⁰ €
+ IVA

DCS570NT-XJ
SEGA CIRCOLARE 184MM



269⁰⁰ €
+ IVA

DCS565NT-XJ
SEGA CIRCOLARE COMPATTA
165MM



334⁰⁰ €
+ IVA

DCS386NT-XJ
SEGA UNIVERSALE



322⁰⁰ €
+ IVA

DCS382N-XJ
SEGA UNIVERSALE*



308⁰⁰ €
+ IVA

DCS367NT-XJ
SEGA UNIVERSALE COMPATTA

NOVITÀ



295⁰⁰ €
+ IVA

DCS496N-XJ
CESOIA PER TAGLI CURVI
E LAMIERE ONDULATE*



189⁰⁰ €
+ IVA

DCD805NT-XJ
TRAPANO A PERCUSSIONE
90NM



227⁰⁰ €
+ IVA

DCD740NT-XJ
TRAPANO AD ANGOLO



189⁰⁰ €
+ IVA

DCF850NT-XJ
AVVITATORE IMPULSI 1/4"
206MM



240⁰⁰ €
+ IVA

DCF922NT-XJ
AVVITATORE IMPULSI 1/2"
406MM



250⁰⁰ €
+ IVA

DCF891NT-XJ
AVVITATORE AD IMPULSI 1/2"
812MM

* Elettrotensile fornito senza valigetta TSTAK

SCEGLI LA SOLUZIONE

319⁰⁰ €
+ IVA

DCF900NT-XJ
AVVITATORE AD IMPULSI 1/2"
1355NM

325⁰⁰ €
+ IVA

DCF897NT-XJ
AVVITATORE AD IMPULSI 3/4"
ALTA POTENZA 950NM

199⁰⁰ €
+ IVA

DCF512N-XJ
CRICCHETTO BRUSHLESS 1/2" *

219⁰⁰ €
+ IVA

DCH172NT-XJ
TASSELLATORE SDS-PLUS 1.4J

319⁰⁰ €
+ IVA

DCH273NT-XJ
TASSELLATORE SDS-PLUS 2.1J

215⁰⁰ €
+ IVA

DCF620NT-XJ
AVVITATORE PER CARTONGESSO

216⁰⁰ €
+ IVA

DCS356NT-XJ
UTENSILE MULTIFUNZIONE

209⁰⁰ €
+ IVA

DCW210NT-XJ
LEVIGATRICE ROTO-ORBITALE
Ø 125MM

209⁰⁰ €
+ IVA

DCW200NT-XJ
LEVIGATRICE ORBITALE
1/4 DI FOGLIO

270⁰⁰ €
+ IVA

DCS334NT-XJ
SEGNETTO ALTERNATIVO

265⁰⁰ €
+ IVA

DCP580NT-XJ
PIALLETTO

212⁰⁰ €
+ IVA

DCS369NT-XJ
SEGA UNIVERSALE COMPATTA

314⁰⁰ €
+ IVA

DCGG571NK-XJ
PISTOLA INGRASSATRICE

309⁰⁰ €
+ IVA

DCE560N-XJ
PISTOLA PER SILICONE
300-310 ML*

419⁰⁰ €
+ IVA

DCE531N-XJ
VIBRATORE PER CEMENTO
AGO 1.2MT TESTA 28.6MM

* Elettrotensile fornito senza valigetta TSTAK

18V XR CHE FA PER TE



520^{.00} €

+ IVA

RAGGIO VERDE

DCLE34031N-XJ
TRACCIATORE LASER 3X 360°
LUCE VERDE



585^{.00} €

+ IVA

RAGGIO VERDE

DCE089NG18-XJ
TRACCIATORE LASER 3X 360°
LUCE VERDE



265^{.00} €

+ IVA

DCV584L-QW
ASPIRATORE SOLIDI E LIQUIDI
7,5 LITRI*



127^{.00} €

+ IVA

DCE512N-XJ
VENTILATORE*



280^{.00} €

+ IVA

DCL074-XJ
FARO LED 360°*



157^{.00} €

+ IVA

DCC018N-XJ
COMPRESSORE*

XR 18V NEL GARDEN

18V
BRUSHLESS

219^{.00} €

+ IVA



DCM565N-XJ
ELETTOSEGA 30CM*

18V
BRUSHLESS

179^{.00} €

+ IVA



DCMHT563N-XJ
TAGLIASIEPI
LUNGHEZZA LAMA 55CM*

18V
BRUSHLESS

189^{.00} €

+ IVA



DCM562PB-QW
SOFFIATORE ASSIALE
VELOCITÀ VARIABILE*

All'acquisto
dello starter kit
e di almeno
2 corpi macchina

**A TUA SCELTA
AVRAI IN DOTAZIONE**

OPPURE



BATTERIA XR 18V 2AH
DCB183-XJ



CARICABATTERIA XR 4A
DCB1104-XJ

* Elettroutensile fornito senza valigetta TSTAK

SEGHE A TAZZA BI-METAL

FORATURA SU MATERIALI SPESSI CON UN SOLO PASSAGGIO

Il corpo della tazza più lungo permette di forare il legno, legno con chiodi, metallo e plastica e materiali duri 2 volte più velocemente.

DURA FINO A 2 VOLTE*
FORMA DENTE BREVETTATA
OTTIMIZZA RIMOZIONE DETRITI



DESIGN PIÙ PROFONDO
per forare materiali spessi

ESPULSIONE RAPIDA DEL MATERIALE

KIT

- DT90350-QZ** Kit Generico 13 pz - 16 / 19 / 25 / 32 / 38 / 44 / 48 / 51 / 64mm + 2 mandrini + 2 punte - **122,00€** + Iva
- DT90351-QZ** Kit Generico 11 pz - 16 / 20 / 25 / 32 / 40 / 51 / 64mm + 2 mandrini + 2 punte - **107,90€** + Iva
- DT90352-QZ** Kit Elettrocista 11 pz - 20 / 25 / 32 / 35 / 44 / 51 / 64mm + 2 mandrini + 2 punte - **107,90€** + Iva
- DT90353-QZ** Kit Generico 11 pz - 22 / 29 / 35 / 44 / 51 / 64 / 68mm + 2 mandrini + 2 punte - **115,00€** + Iva
- DT90354-QZ** Kit Elettrocista 11 pz - 16 / 20 / 25 / 32 / 35 / 51 / 64mm + 2 mandrini + 2 punte - **115,00€** + Iva
- DT90355-QZ** Kit Idraulico 11 pz - 19 / 22 / 29 / 38 / 44 / 51 / 57mm + 2 mandrini + 2 punte - **115,00€** + Iva
- DT90361-QZ** Kit Generico 13 pz - 20 / 22 / 25 / 32 / 35 / 38 / 44 / 51 / 64mm + 2 mandrini + 2 punte - **133,50€** + Iva

CODICE	DESCRIZIONE	€ s/IVA	CODICE	DESCRIZIONE	€ s/IVA	CODICE	DESCRIZIONE	€ s/IVA
DT90295-QZ	Ø 14mm	15,70 €	DT90313-QZ	Ø 41mm	17,20 €	DT90333-QZ	Ø 86mm	28,90 €
DT90297-QZ	Ø 17mm	15,70 €	DT90315-QZ	Ø 44mm	21,80 €	DT90338-QZ	Ø 102mm	35,10 €
DT90301-QZ	Ø 22mm	14,00 €	DT90319-QZ	Ø 52mm	20,20 €	DT90344-QZ	Ø 127mm	41,90 €
DT90303-QZ	Ø 25mm	14,40 €	DT90322-QZ	Ø 57mm	21,80 €	DT90346-QZ	Ø 152mm	50,00 €
DT90309-QZ	Ø 35mm	17,90 €	DT90324-QZ	Ø 64mm	20,60 €	DT8266-QZ	Ø 177mm	51,40 €
DT90311-QZ	Ø 38mm	17,10 €	DT90327-QZ	Ø 68mm	25,00 €	DT8267-QZ	Ø 210mm	51,80 €

DESIGN VERSATILE

i denti in Carburo di Tungsteno sono ottimizzati per tagliare una varietà di materiali tra cui legno con chiodi, blocchi di cemento, fibrocemento e mattoni



DURATA INCREDIBILE

I riporti in carburo di tungsteno ad alte prestazioni sono brasati al tagliente, questo consente di strappare i chiodi prevenendo la perdita dei denti



6x PIÙ VELOCE
di una bi-metallica



SEGHE A TAZZA MULTIMATERIALE AL CARBURO DI TUNGSTENO

FORATURA SU MATERIALI SPESSI CON UN SOLO PASSAGGIO

Il corpo della tazza è più lungo e permette di forare il legno, legno con chiodi, plastica, metallo, mattoni, cartongesso, ceramica, piastrelle, poroton, acciaio strutturale e materiali duri 2 volte più velocemente. 60 mm di capacità di perforazione.

CODICE	DESCRIZIONE	€ s/IVA	CODICE	DESCRIZIONE	€ s/IVA	CODICE	DESCRIZIONE	€ s/IVA
DT90400-QZ	Ø 19mm	16,00 €	DT90410-QZ	Ø 44mm	18,40 €	DT90418-QZ	Ø 76mm	30,10 €
DT90402-QZ	Ø 22mm	16,00 €	DT90411-QZ	Ø 51mm	20,80 €	DT90420-QZ	Ø 86mm	33,40 €
DT90404-QZ	Ø 30mm	18,40 €	DT90412-QZ	Ø 57mm	25,20 €	DT90421-QZ	Ø 92mm	35,10 €
DT90406-QZ	Ø 35mm	20,60 €	DT90414-QZ	Ø 64mm	23,70 €	DT90423-QZ	Ø 102mm	40,30 €
DT90408-QZ	Ø 40mm	19,80 €	DT90417-QZ	Ø 70mm	29,10 €	DT90426-QZ	Ø 127mm	48,20 €

PUNTE ATTACCO 1/4" BLACK&GOLD PER AVVITATORI AD IMPULSI

NOVITÀ

Angolo punta di 135° anche sui diametri piccoli per ridurre lo slittamento e aumentare la precisione del foro. La geometria della punta aumenta la velocità di foratura. Costruita in un unico blocco con nucleo rastremato, estrema robustezza e resistenza alle coppie degli avvitatori a impulsi. Utilizzo specifico su metallo, alluminio e plastica.



Punta 135° antislittamento
Il design della punta a 135° aiuta a ridurre lo slittamento



FINITURA Nero e Dorata
Aiuta a prevenire la ruggine



Durata / Robustezza
Design a nucleo conico, estrema durata e resistenza alla rottura



IMPACT READY®
Attacco esagonale 1/4" progettato per resistere alla coppia degli avvitatori ad impulsi e compatibile con la maggior parte dei trapani elettrici

CODICE	Ø x L TOT x L UTILE	€ s/IVA
DT20600-QZ	2 x 55 x 15 mm	2,00 €
DT20601-QZ	2.5 x 60 x 20 mm	2,15 €
DT20602-QZ	3 x 72 x 34 mm	2,64 €
DT20603-QZ	3.5 x 76 x 38 mm	2,80 €
DT20604-QZ	4 x 80 x 45 mm	3,08 €
DT20605-QZ	4.5 x 86 x 48 mm	3,40 €
DT20606-QZ	5 x 95 x 56 mm	4,04 €
DT20607-QZ	5.5 x 98 x 59 mm	4,36 €
DT20608-QZ	6 x 102 x 63 mm	4,60 €
DT20609-QZ	6.5 x 105 x 67 mm	4,68 €

CODICE	Ø x L TOT x L UTILE	€ s/IVA
DT20610-QZ	7 x 111 x 73 mm	4,84 €
DT20611-QZ	7.5 x 114 x 76 mm	5,24 €
DT20612-QZ	8 x 117 x 79 mm	5,48 €
DT20613-QZ	8.5 x 120 x 82 mm	5,67 €
DT20614-QZ	9 x 127 x 89 mm	6,31 €
DT20615-QZ	9.5 x 130 x 92 mm	7,19 €
DT20616-QZ	10 x 138 x 100 mm	7,92 €
DT20617-QZ	11 x 145 x 107 mm	8,88 €
DT20618-QZ	12 x 145 x 107 mm	10,08 €
DT20605-QZ	13 x 145 x 107 mm	11,20 €

DT20620-QZ SET 10 PUNTE IMPACT BLACK&GOLD IN CASSETTA: 3, 3.5, 4, 4.5, 5 X2, 6 X2, 8, 10MM



NOVITÀ

PUNTE ELICOIDALI PER FORARE METALLO, LEGNO, PLASTICA



NUOVO DISEGNO DELLA PUNTA
Forature più veloci



NUOVA FINITURA Nero e Dorata



NUCLEO CENTRALE RINFORZATO aumenta la resistenza alla rottura



CODOLO TRIANGOLARE
Alta tenuta evita slittamenti nel mandrino

PUNTE COBALTO EXTREME

Per prestazioni eccezionali in foratura sull'acciaio INOX e materiali non ferrosi. Resistenza garantita fino a 1100 N/mm². Adatto su lamiere dove è richiesta precisione e su tubi senza alcun problema.

NUCLEO CENTRALE IRROBUSTITO
Spessore nucleo centrato maggiore verso il mandrino, migliora resistenza alla rottura, in particolare nell'uso a mano libera

BULINO "NO-WALK"
permette una facile e precisa penetrazione di tutte le superfici.



CODOLO TRIANGOLARE
Migliore presa nel mandrino

CODICE	DESCRIZIONE	€ s/IVA
DT20510-QZ	1 x 34 x 12 mm	1,50 €
DT20511-QZ	1.5 x 40 x 18 mm	1,60 €
DT20514-QZ	3 x 61 x 33 mm	1,50 €
DT20517-QZ	4 x 75 x 43 mm	1,70 €
DT20520-QZ	5 x 86 x 52 mm	2,30 €
DT20522-QZ	6 x 93 x 57 mm	2,60 €

CODICE	DESCRIZIONE	€ s/IVA
DT20523-QZ	6.5 x 101 x 63 mm	3,20 €
DT20524-QZ	7 x 109 x 69 mm	3,60 €
DT20525-QZ	7.5 x 109 x 69 mm	3,90 €
DT20526-QZ	8 x 117 x 75 mm	4,30 €
DT20530-QZ	10 x 133 x 87 mm	6,30 €
DT20536-QZ	13 x 151 x 101 mm	9,90 €

CODICE	Ø	€ s/IVA
DT4902-QZ	2x3 mm	4,70 €
DT4904-QZ	2x4 mm	4,70 €
DT4906-QZ	5 mm	5,80 €
DT4908-QZ	6 mm	5,80 €
DT4912-QZ	8 mm	8,20 €



COMPATIBILE CON BATTERIE
XR FLEX VOLT

**FUNZIONAMENTO A 36V
2 BATTERIE 18V
IN CONTEMPORANEA**

6 ALTEZZE DI TAGLIO
25, 35, 45, 60, 75, 85 mm
Sistema di regolazione
a due leve



**IMPUGNATURA
ERGONOMICA**
Sagomata per
adattarsi alla presa.
Ottimo controllo e
ottimo comfort per
uso prolungato

**DOPPIA
MANIGLIA DI
AVVIAMENTO**

FUNZIONE MULCHING
raccolta erba nel cesto
(capacità 55 lt)

**TELAIO IN METALLO
DA 54CM**
robusto e durevole per
una migliore qualità
di taglio

899.⁰⁰ €
+ IVA

IN DOTAZIONE:
2 batterie 18V/54V 9Ah
+ 1 caricabatterie
DCB118



DCMWSP564N-IT **RASAERBA SEMOVENTE A BATTERIA**

- Maniglia ergonomica
- Doppia maniglia di avviamento
- **SEMOVENTE** per utilizzo prolungato senza fatica
- Funzione mulching
- Scocca in metallo da 54cm
- 6 altezze di taglio
- Ampiezza di taglio 53cm
- Area di taglio:
18V 2x5.0Ah fino a 600mq
54V 2x6.0Ah fino a 900mq
54V 2x9.0Ah fino a 1200mq
- **FUNZIONAMENTO A 36V 2 BATTERIE 18V
IN CONTEMPORANEA**



299.⁰⁰ €
+ IVA



DCM565P1-QW
ELETTOSEGA BARRA 30CM
1 BATTERIA XR 18V 5.0AH



299.⁰⁰ €
+ IVA



DCMPS567P1-QW
POTATORE AD ASTA
1 BATTERIA XR 18V 5.0AH



229.⁰⁰ €
+ IVA



DCMBL562P1-QW
SOFFIATORE ASSIALE
1 BATTERIA XR 18V 5.0AH

DCMHT563P1-QW
TAGLIASIEPI
LAMA 55CM
1 BATTERIA XR
18V 5.0AH



229.⁰⁰ €
+ IVA



DCMPH566P1-QW
TAGLIASIEPI
TELESCOPICO
1 BATTERIA XR
18V 5.0AH



339.⁰⁰ €
+ IVA



DCMPP568P1-QW
CESOIA DA
POTATURA
1 BATTERIA XR
18V 5.0AH



239.⁰⁰ €
+ IVA



DCMST561P1-QW
TAGLIABORDI
36CM
1 BATTERIA XR
18V 5.0AH

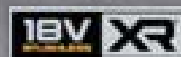

349.⁰⁰ €
+ IVA



GIARDINO

54V XR FLEXVOLT

AUTONOMIA:
FINO A 115 TAGLI PER CARICA*

*su tronchi 150x150mm
con batteria da 15Ah



DCMCS575X1-QW

789.⁰⁰ €

+ IVA

VALIGETTA PER IL
TRASPORTO ROBUSTA.
PROTEGGE LA SEGA
E LA BARRA

ELETTOSEGA 54V FLEXVOLT CON BARRA DA 50CM

- Velocità catena 13,5 m/s
- Peso 5.5Kg
- Tensionamento variabile della catena
- Potenza Max 3000W
- Coppia Max 6.4Nm

Batteria FlexVolt DCB547 9.0Ah

54V XR FLEXVOLT

AUTONOMIA:
FINO A 115 TAGLI PER CARICA*

*su tronchi 150x150mm
con batteria da 15Ah



DCMCS574X1-QW

749.⁰⁰ €

+ IVA

VALIGETTA PER IL
TRASPORTO ROBUSTA.
PROTEGGE LA SEGA
E LA BARRA

ELETTOSEGA 54V FLEXVOLT CON BARRA DA 45CM

- Velocità catena 13,5 m/s
- Peso 5.0Kg
- Tensionamento variabile della catena
- Potenza Max 2000W
- Coppia Max 5.0Nm

Batteria FlexVolt DCB547 9.0Ah

54V XR FLEXVOLT



DCM575X1-QW

539.⁰⁰ €

+ IVA

ELETTOSEGA 54V FLEXVOLT CON BARRA DA 40CM

- Velocità catena 15 m/s
- Peso 4.4Kg
- Tensionamento variabile della catena
- Potenza Max 1700W
- Coppia Max 5.0Nm

Batteria FlexVolt DCB547 9.0Ah

SOFFIATORE ASSIALE BRUSHLESS XR FLEXVOLT

Batteria FlexVolt
DCB547 9.0Ah

54V XR FLEXVOLT



DCMBA572X1-QW

469.⁰⁰ €

+ IVA

SOFFIATORE BRUSHLESS XR FLEXVOLT

Batteria FlexVolt
DCB547 9.0Ah

54V XR FLEXVOLT



DCM572X1-QW

459.⁰⁰ €

+ IVA

DCMAS5713X1-QW MULTIFUNZIONE GARDEN 54V XR

- Impugnatura ergonomica
- Velocità variabile
- Alta / bassa velocità 4650-5800
- Compatto da riporre,
facile da trasportare
- Rocchetto tecnologia
Quick-Load™
- Peso 6.5Kg

589.⁰⁰ €

+ IVA

IN DOTAZIONE:
Attacco decespugliatore,
Batteria 54V 9.0Ah,
Caricabatterie, borsa

LEGGERO E COMPATTO 6,5 KG

MECCANISMO
DI SGANCIO RAPIDO
compatto da riporre
e facile da trasportare



AMPIEZZA DI TAGLIO
38cm

DOPPIO FILO DI NYLON DeWALT 2.4mm
per un taglio sempre perfetto

ATTACCO
POTATORE

DCMASPS5N-XJ

129.⁰⁰ €

+ IVA

ATTACCO
DECESPUGLIATORE

DCMASBC1N-XJ

109.⁰⁰ €

+ IVA

ATTACCO
TAGLIASIEPI

DCMASPH6N-XJ

159.⁰⁰ €

+ IVA

ATTACCO
TAGLIABORDI

DCMASST1N-XJ

99.⁰⁰ €

+ IVA

LEGGEREZZA SENZA LIMITI

ACQUISTA UN ELETTROUTENSILE 12V
DI QUESTA PAGINA ED
AVRAI LA 3^a BATTERIA
XR 12V DA 2AH

DCB127-XJ *



12V XR
BRUSHLESS

DCD701D2-QW
TRAPANO AVVITATORE
12V XR 2AH



205⁰⁰ €
+ IVA

**MANDRINO
IN METALLO!**



DCD706D2-QW
TRAPANO AVVITATORE
A PERCUSSIONE
12V XR 2AH



230⁰⁰ €
+ IVA

290⁰⁰ €
+ IVA



**DCD703L2T-QW TRAPANO
AVVITATORE MULTITESTA 1/4"**
BRUSHLESS 12V XR 3AH

- Coppia 57.5Nm
- Velocità a vuoto 0-425/0-1.500 giri/min
- Peso 1.1Kg
- 15 punti di frizione
- Max. Ø legno/metallo: 20/10 mm

DOTAZIONE: 4 teste intercambiabili, gancio per cintura, 2 batterie XR 12V 3Ah, caricabatterie, valigetta TSTAK

DCH072L2-QW
TASSELLATORE SDS-PLUS
BRUSHLESS 14MM 12V XR 3AH

- 4280 percussioni al minuto
- 2 modalità (foratura con percussione, foratura)
- Potenza del colpo (EPTA 05/2009) 1.1J
- Max foratura [Cemento] 14mm
- Peso 1.9Kg

DOTAZIONE: 2 batterie XR 12V 3Ah, gancio per cintura, caricabatterie, valigetta TSTAK

359⁰⁰ €
+ IVA



287⁰⁰ €
+ IVA



DCS353D2-QW
UTENSILE MULTIFUNZIONE
BRUSHLESS 12V XR 2AH

- Angolo oscillazione destra/sinistra 1.6°
- Velocità variabile
- Orbite/min 0-18000
- Cambio accessori senza utensili
- Luce LED
- Peso (solo corpo macchina) 0.9Kg

DOTAZIONE: Set accessori per tagli e levigatura, adattatore universale, adattatore per aspirazione, 2 batterie XR 12V 2Ah, caricabatterie, valigetta TSTAK

* La 3a batteria è in dotazione solo sui seguenti codici: DCD701D2-QW, DCD706D2-QW, DCD703L2T-QW, DCH072L2-QW e DCS353D2-QW



DCF901P2-QW

345.⁰⁰ €
+ IVA



DCF903P2-QW

345.⁰⁰ €
+ IVA



DCF901P2-QW / DCF903P2-QW AVVITATORE AD IMPULSI 12V XR 5AH

- Attacco 1/2" (DCF901) - 3/8" (DCF903)
- Coppia sostenuta 340Nm
- Coppia di picco 500Nm
- Max Ø bullone M16

DOTAZIONE: 2 batterie 12V XR 5Ah, caricabatteria, valigetta TSTAK

PRECISION
DRIVE

237.⁰⁰ €
+ IVA



DCF801D2-QW
AVVITATORE AD IMPULSI 1/4"
12V XR 2AH - 163 NM

PRECISION
WRENCH

237.⁰⁰ €
+ IVA



DCF902D2-QW
AVVITATORE AD IMPULSI 3/8"
12V XR 2AH - 163 NM

215.⁰⁰ €
+ IVA



DCF601D2-QW
AVVITATORE 1/4"
12V XR 2AH - 8 NM

CON BATTERIA

3AH



359.⁰⁰ €
+ IVA



DCK2110L2T-QW KIT 12V XR 3AH

DCD701 TRAPANO AVVITATORE

- Coppia massima 57Nm
- Velocità 0-425 / 0-1500 gir/min

DCF801 AVVITATORE AD IMPULSI 1/4"

- Coppia massima 163Nm
- 3 velocità 0-1000/1500/2600 giri/min
- Portainseriti a sgancio rapido da 1/4"

DOTAZIONE: 2 batterie 12V XR 3Ah, Caricabatterie, Valigetta TSTAK

DCS512P2-QW SEGA CIRCOLARE BRUSHLESS 140MM 12V XR 5AH

- ø lama/foto 140/20mm
- Velocità lama 3600 Giri/min
- Max inclinazione testa 50°
- Max profondità taglio 90/45° 47/33mm
- Freno elettronico
- Luce Led

DOTAZIONE: lama tct 24 denti, 2 batterie 12V XR 5Ah, caricabatterie, guida parallela, chiave di servizio, adattatore aspirazione AirLock, TSTAK

400.⁰⁰ €
+ IVA





I VANTAGGI DELLA STRUMENTAZIONE LASER DEWALT



UNA GAMMA COMPLETA PER SVOLGERE IL LAVORO IN MENO TEMPO, AUMENTANDO LA PRODUTTIVITÀ.

NUOVA TECNOLOGIA CON DOPPIA COMPATIBILITÀ DELLE BATTERIE 12V/18V XR.

CENTRO ASSISTENZA INTERNO DEDICATO, DOTATO DELLE MIGLIORI TECNOLOGIE PER RIPARAZIONI, TARATURE E CERTIFICAZIONI.

DCLE34021D1-QW TRACCIATORE LASER A CROCE 90°

- DIODO VERDE (CL 2 510-530nm) Luce pulsante
- Interruttore con blocco del pendolo
- Autolivellamento +/- 4°
- Precisione +/- 3mm / 10 mt
- Grado di protezione IP54
- Visibilità max 55mt (100mt con ricevitore)
- Memorizza l'ultima selezione dei raggi
- Base pivotante con magneti
- Attacco treppiede ¼" e 5/8" su supporto a parete

DOTAZIONE:

1 batteria 18V XR 2Ah, caricabatteria, supporto da parete, target verde, valigetta

315^{.00} €
+ IVA

NOVITÀ



NOVITÀ

KIT TRAPANO + TRACCIATORE 3 LINEE 18V XR DCK2095D2T-QW

- **DCD805 TRAPANO A PERCUSSIONE**
Potenza 90Nm
Velocità 0-650/2000 giri/min
Percussioni 0-34000 min
 - **DCLE34031 Tracciatore a 3 linee 360°**
Diodo verde
Autolivellamento +/- 4mm
Precisione +/- 3 mm/10m
Visibilità max 40m (100m con ricevitore)
- DOTAZIONE:**
2 batterie 18V XR 2Ah, caricabatteria, supporto da parete, target verde, valigetta

699^{.00} €

+ IVA

18V XR



605^{.00} €

+ IVA

RAGGIO VERDE

18V XR



DCLE34031D1-QW TRACCIATORE A 3 LINEE 360° (1 ORIZZONTALE + 2 VERTICALI A 90°)

- **DIODO VERDE (CL 2 510-530nm)** Luce pulsante
- Autolivellamento +/- 4°
- Precisione +/- 3mm/10m
- Visibilità max 40m (100m con ricevitore)
- Effetto memoria dell'ultima posizione del raggio
- Base magnetica
- Attacco treppiede 1/4" + 5/8" su supp. a parete

DOTAZIONE:

1 Batteria 18V XR 2Ah, caricabatteria, supporto da parete, target verde, valigetta

DCE089D1G18-QW TRACCIATORE A 3 LINEE 360°

- Autolivellamento +/- 4°
- Precisione +/- 3mm/10m
- Visibilità max 30 Mt (50 Mt con ricevitore)
- Base magnetica e pivottante
- Attacco treppiede 1/4" + 5/8"

DOTAZIONE: 1 Batteria 18V XR 2Ah, caricabatteria, supporto da parete, Target verde, valigetta TSTAK

660^{.00} €

+ IVA

RAGGIO VERDE

DOPPIA COMPATIBILITÀ
12V / 18V



DCE089D1G-QW

RAGGIO VERDE

605^{.00} €

+ IVA

Visibilità max 30 Mt
(50 Mt con ricevitore)

DCE089D1R-QW

RAGGIO ROSSO

470^{.00} €

+ IVA

Visibilità max 15 Mt
(50 Mt con ricevitore)



TRACCIATORE A TRE LINEE 360° (2 VERTICALI A SQUADRO + 1 ORIZZONTALE)

- Autolivellamento +/- 4°
- Precisione +/- 3mm/10m
- Base magnetica e pivottante
- Attacco treppiede 1/4" + 5/8"

DOTAZIONE: 1 batteria 12V XR 2.0Ah, caricabatterie, supporto da parete, target, occhiali, valigetta TSTAK.

TRACCIATORI LASER

12V XR

445.⁰⁰ €
+ IVA

RAGGIO VERDE
Visibilità max 45 Mt punti / 20Mt linee (50 Mt con ricevitore)

DCE0822D1G-QW TRACCIATORE A CROCE 90° + 2 PUNTI PIOMBO

- Autolivellamento +/- 4°
- Precisione +/- 3mm/10m
- Blocco pendolo
- Base magnetica e pivottante
- Attacco treppiede 1/4" + 5/8"

DOTAZIONE: 1 batteria 12V XR 2Ah, caricabatterie, supporto da parete, target, occhiali, valigetta TSTAK

12V XR

445.⁰⁰ €
+ IVA

RAGGIO VERDE
Visibilità max 45 Mt punti / 20Mt linee (50 Mt con ricevitore)

DCE0825D1G-QW TRACCIATORE A CROCE 90° + 5 PUNTI (2 PIOMBO + 1 FRONTALE + 2 LATERALI A 90°)

- Autolivellamento +/- 4°
- Precisione +/- 3mm/10m
- Blocco pendolo
- Base magnetica e pivottante
- Attacco treppiede 1/4" + 5/8"

DOTAZIONE: 1 batteria 12V XR 2Ah, caricabatterie, supporto da parete, target, occhiali, valigetta TSTAK

RAGGIO ROSSO

DW088K-XJ
172.⁰⁰ €
+ IVA

DW088KTRI-XJ
249.⁰⁰ €
+ IVA

IN DOTAZIONE CAVALLETTA DE0881

TRACCIATORE A CROCE 90° RAGGIO ROSSO

- Autolivellamento +/- 4°
- Precisione +/- 3mm/10m
- Visibilità max 15 Mt (50 Mt con ricevitore)
- Base magnetica e pivottante
- Attacco treppiede 1/4"

DOTAZIONE: 3 batterie AA, supporto da parete, valigetta

239.⁰⁰ €
+ IVA

RAGGIO ROSSO

DW0822-XJ TRACCIATORE A CROCE 90° + 2 PUNTI PIOMBO

- Autolivellamento +/- 4°
- Precisione +/- 3mm/10m
- Visibilità max 30 Mt (50 Mt con ricevitore)

DOTAZIONE: 3 batterie AA, supporto magnetico da parete, valigetta

219.⁰⁰ €
+ IVA

RAGGIO VERDE

DW088CG-XJ TRACCIATORE A CROCE 90° LUCE VERDE

- Autolivellamento +/- 4°
- Precisione +/- 3mm/10m
- Visibilità max 30 Mt (50 Mt con ricevitore)

DOTAZIONE: 3 batterie AA, supporto magnetico da parete, valigetta

355.⁰⁰ €
+ IVA

RAGGIO ROSSO

DW089K-XJ TRACCIATORE 3 LINEE LUCE ROSSA

- Autolivellamento +/- 4°
- Precisione +/- 3mm/10m
- Visibilità max 15 Mt (50 Mt con ricevitore)

DOTAZIONE: 4 batterie AA, supporto magnetico da parete, valigetta

DCE080D1GS-QW
1.830.⁰⁰ €
+ IVA

RAGGIO VERDE
Visibilità max 30 Mt (300 Mt con ricevitore)

DCE080D1RS-QW
1.540.⁰⁰ €
+ IVA

RAGGIO ROSSO
Visibilità max 30 Mt (300 Mt con ricevitore)

IN DOTAZIONE CON I LASER ROTATIVI UN CAVALLETTA DE0736-XJ

LASER ROTATIVO AUTOLIVELLANTE + PIOMBO BLUETOOTH

- Autolivellamento +/- 4°
- Precisione +/- 1.5mm/30m
- Connessione Bluetooth per accensione e controllo strumento
- Doppia pendenza +/- 10% regolabile con app Toolconnect, connessa a Bluetooth
- Attacco treppiede 5/8"

DOTAZIONE: 1 batteria 18V XR 2Ah, caricabatterie, ricevitore, supporto da parete, telecomando, scheda bersaglio, occhiali, valigetta TSTAK.

DCE079D1G-QW
1.450.⁰⁰ €
+ IVA

RAGGIO VERDE
Visibilità max 38 Mt (300 Mt con ricevitore)

DCE079D1R-QW
1.220.⁰⁰ €
+ IVA

RAGGIO ROSSO
Visibilità max 30 Mt (300 Mt con ricevitore)

LASER ROTATIVO AUTOLIVELLANTE + PIOMBO

- Autolivellamento +/- 4°
- Precisione +/- 1.5mm/30m
- Doppia pendenza manuale fino a +/-10%
- Attacco treppiede 5/8"

DOTAZIONE: 1 batteria 18V XR 2Ah, caricabatterie, ricevitore, supporto da parete, telecomando, scheda bersaglio, occhiali, valigetta TSTAK.

MISURATORI LASER

DW055PL-XJ

16 METRI

- Misura da 0,165 a 16 metri
- Precisione tipica +/- 6mm/10m
- 620/680Nm >1Nw
- Funzioni: misurazione lineare e continua
- Batteria al litio ricaricabile cavo USB



38⁰⁰ €

+ IVA

DWHT77100-XJ

30 METRI

- Precisione +/- 3 mm/10m
- Calcolo area, volume e pitagora
- Corpo sovrastampato in gomma per una miglior presa
- Compatto e leggero
- Alimentazione 2 batterie tipo AAA (in dotazione)



71⁰⁰ €

+ IVA

DW03050-XJ

50 METRI

- Misura da 0,05 a 50 metri
- Precisione tipica 1,5mm
- Squadretta pieghevole, inclinometro

FUNZIONI: misura lineare, continua, addizioni e sottrazioni, volumi, 2 Pitagora, 5 memorie.

DOTAZIONE: 2 batterie AAA, Fodero.



151⁰⁰ €

+ IVA

DISPLAY RETROILLUMINATO



DW03101-XJ

100 METRI

- Misura da 0,05 a 100 metri
- Precisione tipica 1,5mm
- Squadretta ripieghevole

FUNZIONI: misura lineare, continua, addizioni e sottrazioni, volumi, 3 Pitagora, inclinometro, tracciamento, display a 3 linee, 20 memorie.

DOTAZIONE: 2 batterie AAA, Fodero.



237⁰⁰ €

+ IVA

DISPLAY RETROILLUMINATO



ACCESSORI LASER

RICEVITORI PER LASER A LINEA

- Portata 50 metri
- Due livelli di precisione
- Allarme sonoro a 3 livelli

RAGGIO VERDE

DE08926-XJ

125⁰⁰ €

+ IVA



RAGGIO ROSSO

DE0892-XJ

125⁰⁰ €

+ IVA

DE0733-XJ TREPPIEDE TELESCOPICO

- Altezza da cm 120 a 240
- Regolazione altezza con manovella

100⁰⁰ €

+ IVA



DE0735-XJ TREPPIEDE TELESCOPICO

- In alluminio
- Altezza max 3 mt
- Regolazione di altezza con manovella
- Attacco 5/8"

205⁰⁰ €

+ IVA



DE0734-XJ ASTA GRADUATA TELESCOPICA

- Graduazione topografica e mm
- Altezza max 4 metri

70⁰⁰ €

+ IVA



DE0737-XJ ASTA LASER GRADUATA CON BOLLA

- Lunghezza massima m.2,40

82⁰⁰ €

+ IVA



DE0882-XJ ASTA CON ATTACCO 1/4"

- Altezza massima m.3,40

113⁰⁰ €

+ IVA



GAMMA TASSELLATORI



**TASSELLATORE
IN LINEA 26MM
DOPPIO
MANDRINO
D25134K-QS**



800 W



2.8 J

189.⁰⁰ €

+ IVA

**TASSELLATORE
IN LINEA 28MM
DOPPIO
MANDRINO
D25144K-QS**



900 W



3.0 J

245.⁰⁰ €

+ IVA

**TASSELLATORE
A "L" 30MM
D25333K-QS**



VIBRATION

DUST



950 W



3.5 J

335.⁰⁰ €

+ IVA

**TASSELLATORE
A "L" 30MM
DOPPIO
MANDRINO
D25334K-QS**



VIBRATION

DUST



950 W



3.5 J

375.⁰⁰ €

+ IVA

**TASSELLATORE
A "L" 32MM
D25413K-QS**



VIBRATION



1000 W



4.2 J

530.⁰⁰ €

+ IVA

PUNTE E SCALPELLI SDS MAX E SDS PLUS



Made in Germany

EXTREME PUNTE SDS-MAX AL CARBURO A TESTA PIENA



SPIRALE A 4 CANALI
Rapida rimozione del materiale

MARCHIO DI USURA (WEAR MARK)
Indica l'accuratezza del ø del foro. Accurata installazione di ancoraggi meccanici.



TAGLIENTI IN CARBURO

Singolo pezzo di carburo con 4 taglianti, progettati per ridurre al minimo le vibrazioni.

IRON BLAST TECHNOLOGY™

Riduce lo stress sulla testa ed incrementa la robustezza lungo tutto il corpo.

CODICE	DIAMETRO	LUNGH. TOT.	Prezzo s/IVA
DT60810-QZ	16 mm	540 mm	60,00 €
DT60812-QZ	18 mm	540 mm	64,30 €
DT60817-QZ	20 mm	540 mm	64,30 €
DT60820-QZ	22 mm	540 mm	66,50 €
DT60823-QZ	24 mm	540 mm	71,90 €
DT60825-QZ	25 mm	540 mm	71,90 €
DT60830-QZ	28 mm	570 mm	85,00 €
DT60833-QZ	30 mm	570 mm	90,50 €
DT60835-QZ	32 mm	570 mm	97,00 €
DT60838-QZ	35 mm	570 mm	111,20 €

XLR PUNTE SDS-PLUS

VELOCITÀ Spirale a 4 canali ottimizza lungo tutta l'elica la rimozione dei detriti per una rapida foratura e fori puliti.

VIBRAZIONI RIDOTTE
Potenza del colpo redistribuita sulle 4 teste taglienti

DURATA Trattamento termico ottimizzato per la massima resistenza. Testa ed corpo indissolubilmente saldati con uno speciale metodo di saldatura.

TESTA IN CARBURO 4 taglianti al carburo evitano inceppamento nel fondino. Garantisce fori puliti ed elevata velocità di foratura.

CODICE	DIAMETRO	LUNGH. TOT.	Prezzo s/IVA
DT8908-QZ	5 mm	160 mm	5,80 €
DT8912-QZ	6 mm	110 mm	5,50 €
DT8913-QZ	6 mm	160 mm	5,70 €
DT8914-QZ	6 mm	210 mm	6,30 €
DT8923-QZ	8 mm	160 mm	6,90 €
DT8924-QZ	8 mm	210 mm	7,10 €
DT8925-QZ	8 mm	260 mm	8,30 €
DT8928-QZ	10 mm	160 mm	7,40 €
DT8929-QZ	10 mm	210 mm	8,50 €
DT8930-QZ	10 mm	260 mm	10,20 €
DT8935-QZ	12 mm	260 mm	12,00 €
DT8936-QZ	12 mm	310 mm	18,50 €
DT8940-QZ	14 mm	260 mm	16,40 €
DT8941-QZ	14 mm	310 mm	18,50 €

EXTREME PUNTE SDS-MAX AL CARBURO

SPIRALE E 4 CANALI
Rapida rimozione del materiale

NUCLEO RINFORZATO
Ottima resistenza all'impatto ed alla rottura. Efficiente trasmissione dell'energia alla testa della punta.

TRASMISSIONE OTTIMALE DEL COLPO
Il nucleo irrobustito permette una più efficiente trasmissione dell'energia ai taglianti della testa. Speciale metodo di saldatura.

PUNTA IN CARBURO La solida testa a 2 taglianti garantisce una veloce ed efficiente velocità di foratura. Testa in carburo e il corpo sono brasati insieme per aumentare robustezza e durata.

CODICE	DIAMETRO	LUNGH. TOT.	Prezzo s/IVA
DT9410-QZ	16 mm	540 mm	56,70 €
DT9412-QZ	18 mm	540 mm	58,90 €
DT9417-QZ	20 mm	540 mm	58,90 €
DT9420-QZ	22 mm	540 mm	60,00 €
DT9423-QZ	24 mm	540 mm	68,70 €
DT9425-QZ	25 mm	540 mm	68,70 €
DT9430-QZ	28 mm	570 mm	79,60 €
DT9433-QZ	30 mm	570 mm	85,00 €
DT9435-QZ	32 mm	570 mm	91,60 €
DT9438-QZ	35 mm	570 mm	103,60 €

PUNTE EXTREME 2 SDS-PLUS 2 TAGLIANTI

SPIRALE A 2 CANALI
Accellera la rimozione del calcostrozzatura dalla punta, riducendo temperatura di lavoro e velocizzando la foratura.

MARCHIO DI USURA (WEAR MARK)*
Indica l'accuratezza del ø del foro. Accurata installazione di ancoraggi meccanici.

TOUGHCORE™
Il nucleo centrale afusolato conferisce forza e resistenza nei fori profondi, riduce la flessione tra la scanalatura e il gambo, prevenendo la frattura della punta.

CODICE	DIAMETRO	LUNGH. TOT.	Prezzo s/IVA
DT9505-QZ	5 mm	160 mm	3,60 €
DT9514-QZ	6 mm	110 mm	3,10 €
DT9515-QZ	6 mm	160 mm	3,40 €
DT9516-QZ	6 mm	210 mm	5,50 €
DT9530-QZ	8 mm	160 mm	4,70 €
DT9531-QZ	8 mm	210 mm	6,30 €
DT9532-QZ	8 mm	260 mm	7,20 €
DT9540-QZ	10 mm	160 mm	4,30 €
DT9541-QZ	10 mm	210 mm	5,30 €
DT9542-QZ	10 mm	260 mm	6,90 €
DT9552-QZ	12 mm	260 mm	5,60 €
DT9553-QZ	12 mm	310 mm	7,00 €
DT9567-QZ	14 mm	260 mm	8,30 €
DT9568-QZ	14 mm	310 mm	9,00 €

SCALPELLI SDS-MAX

Geometria della punta ottimizzata per mantenere l'affilatura e la capacità produttiva. Acciaio appositamente temprato e trattamento termico controllato da microprocessore per garantire punte resistenti e di lunga durata. Testa in acciaio duro per resistere all'usura e demolire in velocità. Corpo in acciaio più morbido per resistere ai contraccolpi e ridurre al minimo le rotture.

CODICE	TIPO	MISURA	Prezzo s/IVA
DT6821-QZ	A Punta	400 mm	17,40 €
DT6823-QZ	Piatto	400x25 mm	17,40 €
DT6824-QZ	Spatola	360x50 mm	33,80 €
DT6825-QZ	Spatola	300x80 mm	34,90 €
DT6889-QZ	A Punta	400 mm	26,20 €
DT6812-QZ	Piatto	400x25 mm	26,20 €
DT6818-QZ	Spatola	360x50 mm	40,30 €

SCALPELLI SDS-PLUS

CODICE	TIPO	MISURA	Prezzo s/IVA
DT6801-QZ	A Punta	250 mm	12,00 €
DT6802-QZ	Piatto	250x20 mm	12,00 €
DT6803-QZ	Spatola	250x40 mm	18,50 €
DT6806-QZ	Piastrelle	250x40 mm	24,00 €
DT6978-QZ	A Punta	250 mm	20,70 €
DT6979-QZ	Piatto	250x20 mm	20,70 €
DT6984-QZ	Spatola	250x40 mm	21,80 €

SPECIALE MARTELLI A FILO



DEMO-PERFORATORI

**MARTELLLO
DEMO-PERFORATORE
10.5J
D25614K-QS**

660⁰⁰ €
+ IVA



1350 W



7.8 kg



8.8 m/s²



45 mm



No



**MARTELLLO
DEMO-PERFORATORE
13.3J
D25733K-QS**

840⁰⁰ €
+ IVA



1600 W



9.5 kg



9.3 m/s²



48 mm



No

**MARTELLLO
DEMO-PERFORATORE
19.4J
D25773K-QS**

899⁰⁰ €
+ IVA



1700 W



10.5 kg



10.5 m/s²



52 mm



No



POTENZA



PESO



VIBRAZIONI



CAPACITÀ MAX
DI FORATURA



DOPIO
MANDRINO



VIBRATION

DEMOLITORI

**MARTELLO
DEMOLITORE
7.1J
D25810K-QS**

435^{.00} €

+ IVA



SDS max



1050 W



5.6 kg



9.4 m/s²

**MARTELLO
DEMOLITORE
10.5J
D25832K-QS**

600^{.00} €

+ IVA



SDS max



1250 W



7.4 kg



8.8 m/s²

**MARTELLO
DEMOLITORE
13.3J
D25872K-QS**

720^{.00} €

+ IVA



SDS max



1600 W



8.8 kg



9.7 m/s²

**MARTELLO
DEMOLITORE
19J
D25902K-QS**

850^{.00} €

+ IVA



SDS max



1550 W



10.5 kg



8.0 m/s²

**MARTELLO
DEMOLITORE
24J
D25951K-QS**

1.045^{.00} €

+ IVA



SDS max



1600 W



13.3 kg



8.8 m/s²

**MARTELLO
DEMOLITORE
35J
EXA 30MM
D25961K-QS**

1.299^{.00} €

+ IVA



1600 W



16.9 kg



6.8 m/s²

**MARTELLO
DEMOLITORE
62J
EXA 28MM
D25981K-QS
CON CARRELLO**

1.890^{.00} €

+ IVA



2100 W



31 kg



4.8 m/s²

SPECIALE MARTELLI

DEMOLITORI 54V



**MARTELLINO
DEMOLITORE
19.4J
DCH892X2-QW**

POSSIBILITÀ
DI ALLOGGIARE
LE BATTERIE
XR FLEXVOLT
15AH
(DCB549-XJ)

54V XR FLEXVOLT 2100



1.099^{.00} €
+ IVA



54 V



8.9 kg



9.4 m/s²

**MARTELLINO
DEMOLITORE
10.5J
DCH832X2-QW**

POSSIBILITÀ
DI ALLOGGIARE
LE BATTERIE
XR FLEXVOLT
15AH
(DCB549-XJ)

54V XR FLEXVOLT 2100



949^{.00} €
+ IVA



54 V



6.5 kg



8.7 m/s²

DEMO-PERFORATORI 54V



**MARTELLINO
DEMO-
PERFORATORE
6.1J
DCH481X2-QW**



54V XR FLEXVOLT 2100



1.085^{.00} €
+ IVA



54 V



6.7 kg



9.4 m/s²

**MARTELLINO
DEMO-
PERFORATORE
10.5J
DCH614X2-QW**



54V XR FLEXVOLT 2100



1.140^{.00} €
+ IVA



54 V



8.3 kg



8.8 m/s²

**MARTELLINO
DEMO-
PERFORATORE
SDS-MAX 13.3J
DCH735X2-QW**

POSSIBILITÀ
DI ALLOGGIARE
LE BATTERIE
XR FLEXVOLT
15AH
(DCB549-XJ)



54V XR FLEXVOLT 2100



1.240^{.00} €
+ IVA



54 V



10 kg



9.0 m/s²

**MARTELLINO
DEMO-
PERFORATORE
SDS-MAX 19.4J
DCH775X2-QW**

POSSIBILITÀ
DI ALLOGGIARE
LE BATTERIE
XR FLEXVOLT
15AH
(DCB549-XJ)

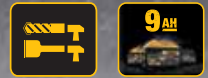

54V XR FLEXVOLT 2100



1.285^{.00} €
+ IVA



54 V



10.9 kg



10.1 m/s²



POTENZA



PESO



VIBRAZIONI



CAPACITÀ MAX
DI FORATURA



DOBPIO
MANDRINO

ASPIRAZIONE

500⁰⁰ €
+ IVA

PERFORM PROTECT

AIR LOCK



DWV901LT-QS ASPIRATORE A FILO SOLIDI/LIQUIDI 30LT CLASSE L 1400W

- Sistema a doppio filtro alternato con pulizia automatica
- Base per aggancio sistema TSTAK

IN DOTAZIONE IL KIT PULIZIA PAVIMENTI DWV9350-XJ



570⁰⁰ €
+ IVA

PERFORM PROTECT

AIR LOCK



DWV902L-QS ASPIRATORE A FILO SOLIDI/LIQUIDI 35LT CLASSE L 1400W

- Sistema a doppio filtro alternato con pulizia automatica
- Tubo flessibile 4metri con Ø 35mm

60⁰⁰ €
+ IVA

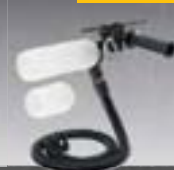

DWH201D-XJ SET DI SISTEMA ESTRAZIONE POLVERI TRAPANI A FILO E TASSELLATORI SDS-PLUS

DWH161D1-QW ASPIRATORE UNIVERSALE 18V XR 2.0AH

- Compatibile con gli utensili di tutti i marchi
- Motore Brushless e filtro HEPA
- Sistema di pulizia manuale del filtro
- Wireless Tool Control
- Peso 1,7 kg

DOTAZIONE: 1 batteria 18V XR 2.0 Ah, caricabatterie, tubo flessibile da 1m, tracolla, gancio per cintura, valigetta Tstak

PERFORM PROTECT

WIRELESS TOOL CONTROL

HEPA



280⁰⁰ €
+ IVA



IDEALE PER FORATURA

DCV501LN-XJ ASPIRATORE A BATTERIA XR 18V CLASSE L

- Portata max aria 1260 litri/min
- Aspirazione con azione ciclonica
- Serbatoio in policarbonato 0.75 litri
- Tubo flessibile Antistatico
- Filtro HEPA lavabile
- Luce LED
- Peso 1.5 kg

DOTAZIONE: Spazzola per pavimenti, tubo flessibile, tubo di prolunga, lancia per fessure, spazzola larga, spazzola tonda, gancio per cintura, senza batteria e caricabatteria, borsa in cordura.

155⁰⁰ €
+ IVA



DCV5011H-XJ FILTRO HEPA DI RICAMBIO LAVABILE

PUNTE CON ASPIRAZIONE INTEGRATA



FORATURA RAPIDA DEL CALCESTRUZZO CON ESTRAZIONE DELLA POLVERE

EXTREME PUNTE CAVE SDS-PLUS E SDS-MAX

FORATURA ESTREMAMENTE VELOCE

CORPO CAVO, PER UN'ELEVATA EFFICIENZA NELL'ESTRAZIONE DELLA POLVERE IN USO CON L'ASPIRATORE

DISPONIBILI ENTRAMBI GLI ATTACCHI SDS-PLUS E SDS-MAX

COLLEGAMENTO DIRETTO CON IL SISTEMA AIRLOCK

GEOMETRIA DELLA PUNTA PROGETTATA PER IL CORRETTO POSIZIONAMENTO, GARANTISCE PRECISIONE NEL LAVORO E MAGGIOR DURATA

PERFORM PROTECT



DESIGN A 2 TAGLIENTI (SDS-PLUS)



DESIGN CON TAGLIANTE A Y (SDS-MAX)

PUNTE SDS-PLUS

CODICE	LU/LT	Ø	Prezzo s/IVA
DT60340-QZ	200 / 320mm	12 mm	82,5 €
DT60341-QZ	250 / 370mm	12 mm	91,8 €
DT60342-QZ	250 / 370mm	12 mm	93,8 €
DT60343-QZ	250 / 370mm	12 mm	98,4 €

PUNTE SDS-MAX

CODICE	LU/LT	Ø	Prezzo s/IVA
DT60230-QZ	400 / 600mm	16 mm	187,5 €
DT60231-QZ	400 / 600mm	18 mm	192,2 €
DT60232-QZ	400 / 600mm	20 mm	201,5 €
DT60233-QZ	400 / 600mm	24 mm	210,9 €
DT60234-QZ	400 / 600mm	28 mm	276,5 €
DT60235-QZ	400 / 600mm	32 mm	285,9 €

SPECIALE CARTONGESSO

DCE555N-XJ REFILATORE PER CARTONGESSO BRUSHLESS 18V XR

- Velocità 26000 giri/min
- Regolazione di profondità
- Luce Led per illuminare l'area di lavoro

DOTAZIONE:
2 pinze e frese da
1/4" e 1/8",
sistema di aspirazione



165.⁰⁰ €
+ IVA

619.⁰⁰ €
+ IVA



KIT ASPIRAZIONE AIRLOCK
(NON IN DOTAZIONE)
DWV9220-XJ

DWE7800-QS LEVIGATRICE PER CARTONGESSO

- Diametro 225mm
- Velocità variabile 1400-2400 giri/min
- Lunghezza totale 1.6 mt
- Testa pivotante e platello forato per massimizzare l'esecuzione del lavoro e l'aspirazione
- Peso 4 kg

CONSIGLIATO CON:

DWF4000250
1.000 VITI
NASTRATE
3,5 x 25 mm

15.⁸⁰ €
+ IVA



345.⁰⁰ €
+ IVA

2AH

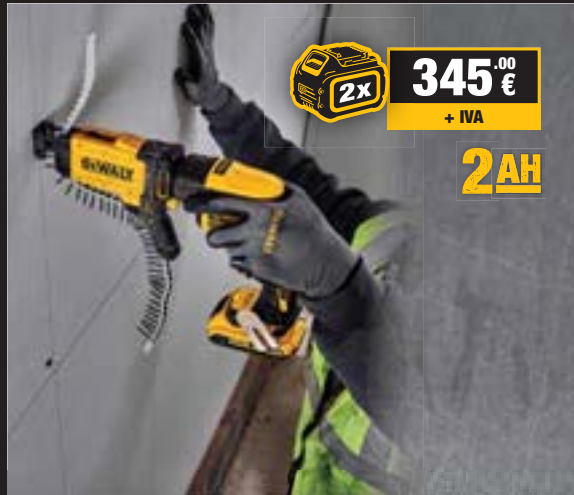

DCF620D2K-QW AVVITATORE PER CARTONGESSO CON MECCANISMO CARICAMENTO VITI 18V XR 2AH

Guide di scorrimento migliorate per un ridotto rischio di inceppamento, maggiore protezione dalla polvere, design modificato per una maggiore accessibilità anche negli angoli.

- Coppia di serraggio 5-30 Nm
- Velocità a vuoto 0-4400 g/m
- Ridotto rischio di inceppamento,

DOTAZIONE: 2 batterie 18V XR 2Ah, caricabatterie, valigetta TSTAK

DCE800T2-QW LEVIGATRICE PER CARTONGESSO

- Levigatura di stucco su pareti in cartongesso
- Diametro 225mm
- Velocità variabile
- Tubo telescopico fino a 1.6 metri
- Sistema Wireless Tool Control

DOTAZIONE:
3 dischi abrasivi P150,
2 batterie XR FV 6Ah,
caricabatterie,
Soft Bag



990.⁰⁰ €
+ IVA



Massima efficienza del sistema di aspirazione



Velocità di lavoro regolabile con selettore



Testa pivotante per il massimo comfort in uso

CONSIGLIATO CON:



ABRASIVO A MAGLIE
PER LEVIGATRICI



14.⁰⁰ €
+ IVA

CODICE	GRANA	Quantità
DTM8680-QZ	60	5
DTM8681-QZ	80	5
DTM8682-QZ	120	5
DTM8684-QZ	150	5
DTM8683-QZ	240	5

SPECIALE SEGHE UNIVERSALI

SEGA UNIVERSALE 54V XR FLEXVOLT

- Motore Brushless
- Corse al minuto 0-2800
- Lunghezza corsa 16mm
- Valigetta
- Caricabatterie rapido

XR FLEXVOLT



6AH
2x

DCS389T2-QW

720.⁰⁰ €

+ IVA

9AH
2x

DCS389X2-QW

825.⁰⁰ €

+ IVA



590.⁰⁰ €

+ IVA



DCS386H2T-QW SEGA UNIVERSALE
18V POWERSTACK 5AH



565.⁰⁰ €

+ IVA



DCS367P2-QW SEGA UNIVERSALE
18V XR 5AH



219.⁰⁰ €

+ IVA

DWE305PK-QS
SEGA UNIVERSALE 1100W

SEGHE ALLIGATOR®

MATTONE

DT2976-QZ DT2974-QZ DT99591-QZ

Lama TCT 450 mm Alta densità
Lama TCT 450 mm Bassa densità
Lama FLEXVOLT HSS 450 mm Alta densità

146.⁰⁰ 83.⁵⁰ 94.⁷⁰



CALCESTRUZZO AREATO

DT2975-QZ

Lama TCT da 450 mm
Calcestruzzo aerato

83.⁵⁰



LEGNO

DT2978-QZ DT99593-QZ

Lama HSS 450 mm Legno morbido e duro
Lama TCT 450 mm Legno morbido e duro

57.³⁰ 56.⁵⁰



ISOLAMENTO

DT2979-QZ

Lama HSS 450 mm
Materiali isolanti

88.⁷⁰



54V XR FLEXVOLT



910.⁰⁰ €

+ IVA



DCS398T2-QW SEGA ALLIGATOR 54V
XR FLEXVOLT POROTON CLASSE 20

- Lunghezza lama 430mm
- Lunghezza corsa 40mm
- Corse/min 2400
- Freno lama 0.2 sec
- Peso 6.5 kg

DOTAZIONE: 2 batterie XR FV 6Ah,
lama TCT per poroton classe 20,
caricabatteria, chiave di servizio

465.⁰⁰ €

+ IVA



DWE398-QS SEGA ALLIGATOR
1700W POROTON CLASSE 20

- Lunghezza lama 430mm
- Lunghezza corsa 40mm
- Corse/min 3000
- Peso 5.5 kg

DOTAZIONE: lama TCT per poroton
classe 20, chiave di servizio

445.⁰⁰ €

+ IVA



DWE397-QS SEGA ALLIGATOR
1700W POROTON CLASSE 12

- Lunghezza lama 430mm
- Lunghezza corsa 40mm
- Corse/min 3000
- Peso 5.5 kg

DOTAZIONE: lama TCT per poroton
classe 12, chiave di servizio

LAME PER SEGA UNIVERSALE BI-METAL



DESIGN RESISTENTE

Le Lame Bi-Metal garantiscono maggiore flessibilità e lunga durata



VERSATILITÀ E VELOCITÀ

Il design dei denti consente un taglio rapido su diversi tipi di materiale

DURANO FINO AL 50% IN PIÙ⁽¹⁾

⁽¹⁾ Prestazioni medie testate rispetto alla gamma precedente

CATEGORIE	LUNGHEZZE DISPONIBILI
Lame Bi-Metal per legno e legno con chiodi	152 / 228 / 305 mm
Lame Bi-Metal per metallo	100 / 152 / 203 / 305 mm
Lame Bi-Metal universali per legno, metallo e PVC	152 / 203 mm
Lame Bi-Metal per legno con chiodi ideali per demolizione	152 / 228 / 305 mm
Lame Bi-Metal per metallo duri e ad alto spessore	152 / 203 mm

SCEGLI LA LAMA MIGLIORE

MATERIALE	LAME HCS		LAME BI-METAL PER DEMOLIZIONE			LAME BI-METAL PLUNGEPOINT						
	DT2352-QZ	DT2432-QZ	DT90380-QZ	DT90381-QZ	DT90382-QZ	DT2351-QZ	DT2359-QZ	DT2349-QZ	DT2350-QZ			
LEGNO												
Lunghezza (mm)	240	305	152	228	304	152	152	228	305			
Lame per confezione	5	5	5	5	5	5	5	5	5			
Numero di denti per pollice (TPI)	4	3	6	6	6	6 / Legno tenero	6 / Legno con chiodi	6	6			
Prezzo €	31,60	21,60	23,80	27,60	32,00	20,40	20,40	24,60	29,20			
MATERIALE	LAME BI-METAL STANDARD					LAME BI-METAL PER METALLI AD ALTO SPESSORE						
	DT2385-QZ	DT2384-QZ	DT2361-QZ	DT2354-QZ	DT2353-QZ	DT90384-QZ	DT90385-QZ	DT90386-QZ	DT90387-QZ	DT90388-QZ	DT90389-QZ	DT90390-QZ
METALLO												
Lunghezza (mm)	152	152	152	203	203	152	152	228	228	228	304	304
Lame per confezione	5	5	5	5	5	5	5	5	5	5	5	5
Numero di denti per pollice (TPI)	23	18	14	18	14	10	14	10	14	18	10	14
Prezzo €	20,40	20,40	22,20	23,30	23,30	15,60	16,50	20,10	20,10	21,00	25,60	26,30
MATERIALE	LAME PER MATERIALI ISOLANTI			LAME PER MATERIALI ISOLANTI								
	DT2450-QZ	DT2451-QZ	DT2452-QZ	DT2332-QZ	DT2333-QZ							
UTILIZZI SPECIALI												
Lunghezza (mm)	225	300	400	152	228							
Lame per confezione	2	2	1	1	1							
Numero di denti per pollice (TPI)	6	6	6	23	18							
Materiali	-	-	-	Ghisa, vetroresina, resine epossidiche, legno con chiodi, mattoni rossi								
Prezzo €	37,90	50,60	47,70	11,20	14,90							

LAME PER SEGA UNIVERSALE BI-METAL CON DENTI AL CARBURO

TAGLI RAPIDI SUL METALLO

Il rivestimento in Titanio rende i denti più forti e più affilati per un taglio veloce



PROGETTATO PER GARANTIRE PRESTAZIONI DI TAGLIO SUPERIORI

Elevata capacità di taglio su diversi metalli come metalli ad altro spessore, ghisa e acciaio inossidabile

TAGLIO DRITTO

IN DIVERSI DIAMETRI

Profilo della lama lungo e spesso ideale per tagli dritti e una maggiore durata delle prestazioni di taglio

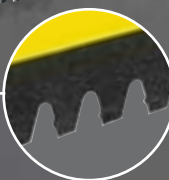

DENTI AL CARBURO

Il Carbuco ad alte prestazioni saldato ai denti garantisce una maggior resistenza e prevenire la perdita dei denti

DURA FINO A 2X IN PIÙ ⁽²⁾ RISPETTO A UNA LAMA TRADIZIONALE

⁽²⁾ Prestazioni medie testate rispetto alla gamma precedente

CODICE	DESCRIZIONE	€ s/IVA
DT20440-QZ	Lama per sega universale con denti al carburo da 152 mm per legno con chiodi / 6TPI	16,40 €
DT20439-QZ	Lama per sega universale con denti al carburo da 230 mm per legno con chiodi / 6TPI	17,40 €
DT20438-QZ	Lama per sega universale con denti al carburo da 305 mm per legno con chiodi / 6TPI	26,40 €
DT20437-QZ	Lama per sega universale con denti al carburo da 102 mm per metallo / 8TPI	12,50 €
DT20436-QZ	Lama per sega universale con denti al carburo da 152 mm per metallo / 8TPI	16,40 €
DT20435-QZ	Lama per sega universale con denti al carburo da 230 mm per metallo / 8TPI	21,50 €

IN BASE ALL'APPLICAZIONE

LAME EXTREME 2X LONG LIFE			LAME EXTREME XR RUNTIME		LAME EXTREME BI-METAL CON DENTI AL CARBURO		
DT2300L-QZ	DT2307L-QZ	DT2314L-QZ	DT99554-QZ	DT99555-QZ	DT20440-QZ	DT20439-QZ	DT20438-QZ
152	228	305	152	230	152	230	305
5	5	5	5	5	1	1	1
6	6	6	6	6	6	6	6
28,30	36,10	44,00	26,80	33,60	17,40	22,00	28,10

LAME EXTREME 2X LONG LIFE								LAME EXTREME XR RUNTIME		LAME EXTREME BI-METAL CON DENTI AL CARBURO		
DT90391-QZ	DT2315L-QZ	DT2301L-QZ	DT2308L-QZ	DT2316L-QZ	DT2407L-QZ	DT2408L-QZ	DT2409L-QZ	DT99553-QZ	DT99552-QZ	DT20437-QZ	DT20436-QZ	DT20435-QZ
304	100	152	228	305	152	203	305	152	230	102	152	230
5	5	5	5	5	5	5	5	5	5	1	1	1
18	10	10	14-18	10	14-18	14-18	14-18	14-18	14-18	8	8	8
26,60	20,30	26,50	33,10	42,90	29,50	37,50	49,70	30,60	38,30	13,30	17,40	22,90

LAME CON DENTI AL CARBURO GRIT				LAME BI-METAL A SPEZZARE	
DT2335-QZ	DT2420-QZ	DT2421-QZ	DT2422-QZ	DT2417-QZ	DT2416-QZ
228	240	305	457	152	230
1	1	1	1	5	5
14	18	14	14	14-18	14-18
Fibrocemento	Calcestruzzo arenato, mattoni, materiali alveolari			Tubi e profilati in metallo ed acciaio (max spessore 10mm)	
40,90	34,40	48,40	69,90	28,10	36,50

SPECIALE SMERIGLIATRICI

BRUSHLESS



226⁰⁰ €
+ IVA

VELOCITÀ FISSA

DWE4347-QS SMERIGLIATRICE ANGOLARE 125mm
1700W / 10500 giri/min

BRUSHLESS



237⁰⁰ €
+ IVA

VELOCITÀ VARIABILE

DWE4357-QS SMERIGLIATRICE ANGOLARE 125mm
1700W / 2200 - 10500 giri/min

BRUSHLESS



237⁰⁰ €
+ IVA

IDEALE PER INOX

DWE4369-QS SMERIGLIATRICE ANGOLARE 125mm
1700W / 1800 - 8000 giri/min



185⁰⁰ €
+ IVA



DWE4257-QS SMERIGLIATRICE ANGOLARE 125mm
1500W / 2800 - 10500 giri/min



120⁰⁰ €
+ IVA

DWE4237-QS SMERIGLIATRICE ANGOLARE 125mm
1400W / 11500 giri/min



78⁰⁰ €
+ IVA

DWE4156-QS SMERIGLIATRICE ANGOLARE 115mm
900W / 11500 giri/min



190⁰⁰ €
+ IVA

DWE4559-QS SMERIGLIATRICE ANGOLARE 230mm
2400W / 6500 giri/min



190⁰⁰ €
+ IVA

DWE492DU01-QS COPPIA DI SMERIGLIATRICI ANGOLARI
DWE4156-QS 115MM 900W + DWE492-QS 230MM 2200W



308⁰⁰ €
+ IVA



DWE4257KT-QS SMERIGLIATRICE
ELETTRONICA 125mm 1500W
CON CUFFIA E TAZZA PER CEMENTO



240⁰⁰ €
+ IVA



DWE492GK-QS SMERIGLIATRICE
ANGOLARE 230mm 2200W CON CUFFIA
DI ASPIRAZIONE E DISCO DIAMANTATO



DWE46225-XJ Ø 125mm
125⁰⁰ €
+ IVA



Ø 230mm
180⁰⁰ €
+ IVA



DWE46225-XJ / DWE46229-XJ
CUFFIE DI ASPIRAZIONE
PER SMERIGLIATRICI

ABRASIVI E ACCESSORI DIAMANTATI

DISCHI DIAMANTATI SINTERIZZATI

DISCO SEGMENTATO

MATERIALI RACCOMANDATI

Granito, Cemento, Pietra naturale, Clinker, Mattone refrattario, Ardesia, Arenaria



CODICE	MISURA	€ s/IVA
DT3701-QZ	115 x 7mm	11,40
DT3711-QZ	125 x 7mm	13,20
DT3731-QZ	230 x 7mm	41,10

DISCO CORONA TURBO

MATERIALI RACCOMANDATI

Laterizio, Arenaria, Clinker, Calcestruzzo poroso, Pietra naturale



CODICE	MISURA	€ s/IVA
DT3702-QZ	115 x 7mm	11,40
DT3712-QZ	125 x 7mm	13,20
DT3732-QZ	230 x 7mm	41,10

DISCO CORONA CONTINUA

MATERIALI RACCOMANDATI

Piastrelle in porcellana, Piastrelle in ceramica, Gres, Marmo



CODICE	MISURA	€ s/IVA
DT3703-QZ	115 x 5mm	10,20
DT3713-QZ	125 x 5mm	12,10
DT40207-QZ	230 x 5mm	37,40

TAZZE DIAMANTATE

CARATTERISTICHE • Segmenti diamantati di grande dimensione per un'ottima durata
• Alta concentrazione di grana diamantata per una grande velocità • Corpo in acciaio temprato

CORONA SINGOLA



CODICE	MISURA	€ s/IVA
DT3795-QZ	125mm	44,70

CORONA DOPPIA



CODICE	MISURA	€ s/IVA
DT3796-QZ	125mm	78,50

CORONA TURBO



CODICE	MISURA	€ s/IVA
DT3797-QZ	125mm	83,40

EXTREME METAL

DISCHI DA TAGLIO per metalli per una durata estrema

1000+ TAGLI
PER IL 99,9% DEI METALLI
Durezza in Abrasivi Legati

Progettati specificamente per fornire durata e prestazioni estreme. Questi dischi da taglio possono essere utilizzati con le smerigliatrici angolari a batteria e a filo, su una ampia gamma di metalli ferrosi e non.



N. CAT.	Ø	FORO	SPESSORE	€ s/IVA
DT40251-QZ	115mm	22,23mm	1,3mm	15,70
DT40252-QZ	125mm	22,23mm	1,3mm	19,30
DT40255-QZ	230mm	22,23mm	2,1mm	42,30

DISCHI LAMELLARI



CODICE	MISURA	€ s/IVA
DT3292-QZ	115mm 36g	2,20
DT3293-QZ	115mm 60g	2,20
DT3294-QZ	115mm 80g	2,20
DT3308-QZ	125mm 36g	2,50
DT3309-QZ	125mm 60g	2,50
DT3310-QZ	125mm 80g	2,50

DISCHI ABRASIVI

HIGH PERFORMANCE

- Grana professionale in ossido di alluminio progettata per utensili a batteria per massimizzare la durata e le prestazioni.

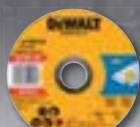

CODICE	Ø	SPESSORE	MATERIALE	TIPO	€ s/IVA
DWA8062SIA-AE	115mm	1,2mm	INOX	Taglio	0,70
DWA8434SIA-AE	115mm	3mm	INOX	Taglio	0,90
DT42340Z-QZ	125mm	1,2mm	INOX	Taglio	0,90
DWA4522SIA-AE	125mm	3mm	INOX	Taglio	1,00
DT42380Z-QZ	180mm	1,2mm	INOX	Taglio	1,70
DWA4524SIA-AE	180mm	3mm	INOX	Taglio	1,70
DWA4525SIA-AE	230mm	3mm	INOX	Taglio	2,10
DWA4514IA-AE	115mm	6mm	METALLO	Sbavo	1,20
DW4543AIA-AE	125mm	6mm	METALLO	Sbavo	1,30
DW4547AIA-AE	180mm	6mm	METALLO	Sbavo	2,30
DW4549AIA-AE	230mm	6mm	METALLO	Sbavo	3,30

EXTREME

- Grana industriale in ossido di alluminio progettata per massimizzare la durata e le prestazioni.
- Accreditato OSA.
- Concentrazione di grani ad alta densità per una maggiore durata.

EXTREME



CODICE	Ø	SPESSORE	MATERIALE	TIPO	€ s/IVA
DT3442-QZ	115mm	1mm	INOX	Taglio	0,90
DT43903-QZ	115mm	1,2mm	INOX	Taglio	0,90
DT43905-QZ	115mm	1,6mm	INOX	Taglio	0,90
DT43902-QZ	125mm	1mm	INOX	Taglio	1,20
DT43904-QZ	125mm	1,2mm	INOX	Taglio	1,20
DT43909-QZ	230mm	2mm	INOX	Taglio	2,40
DX7921-AE	115mm	6mm	METALLO	Sbavo	1,40
DX7941-AE	125mm	6mm	METALLO	Sbavo	1,60
DT43919-QZ	230mm	6mm	METALLO	Sbavo	3,60

535⁰⁰ €

+ IVA

**DCS570P2-QW SEGA CIRCOLARE
184MM 18V XR 5AH**

- Max prof. di taglio 90/45° 65/45mm
- Max inclinazione di taglio fino a 57°

DOTAZIONE: lama, 2 batterie 18V XR 5Ah, caricabatterie, guida parallela, chiave servizio, adattatore aspirazione, TSTAK

265⁰⁰ €

+ IVA

**DWE576K-QS
SEGA CIRCOLARE 190MM 1600W**

- Max prof. taglio a 90/45° 61/49mm
- Max inclinazione testa 57°
- Scarpa in all., utilizzo con guida rettilinea
- Valigetta

159⁰⁰ €

+ IVA

**DWE560-QS
SEGA CIRCOLARE 184MM 1350W**

- Max prof. taglio a 90/45° 65/42mm
- Max inclinazione testa 48°

475⁰⁰ €

+ IVA

**DCS565P2-QW SEGA
CIRCOLARE COMPATTA
BRUSHLESS 165MM 18V XR 5AH**

- Max inclinazione testa 50°
- Max prof. taglio 90/45° 55/42mm
- Freno elettronico
- Luce Led

DOTAZIONE: lama tct 24 denti, 2 batterie 18V XR 5Ah, caricabatterie, guida parallela, chiave di servizio, adattatore aspirazione AirLock, TSTAK

139⁰⁰ €

+ IVA

**DWE349-QS SEGHE
TTO ALTERNATIVO
IMPUGNATURA
A STAFFA 650W**

- Corse min 500-3200
- Lunghezza corsa 20mm
- Pulsante Lock-On
- Max taglio legno/alluminio/acciaio 85/20/10 mm
- Pendolarismo 4 posizioni
- Cambio lama e inclinazione base senza utensili

DOTAZIONE: adattatore scarpa antigraffio, in scatola di cartone

540⁰⁰ €

+ IVA

**DCS334P2-QW
SEGHE
TTO ALTERNATIVO
18V XR 5AH
IMPUGNATURA A STAFFA
BRUSHLESS**

- Corse min 0-3200
- Lunghezza corsa 26 mm
- Max taglio legno/acciaio 135/10mm

DOTAZIONE: accessorio per aspirazione, protezione antigraffio, inserto antisceggia



540⁰⁰ €

+ IVA

**DCS335P2-QW
SEGHE
TTO ALTERNATIVO
18V XR 5AH
IMPUGNATURA SUL CORPO
BRUSHLESS**

- Corse min 1000-3200
- Lunghezza corsa 26 mm
- Max taglio legno/acciaio 135/10mm

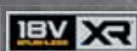
DOTAZIONE: accessorio per aspirazione, protezione antigraffio, inserto antisceggia

255⁰⁰ €

+ IVA

**DW331KT-QS
SEGHE
TTO ALTERNATIVO
701W
IMPUGNATURA A STAFFA**

- Corse min 800-3100
- Max taglio legno /alluminio/acciaio 130/20/10mm

DOTAZIONE: 4 lame, accessorio per aspirazione, protezione antigraffio, inserto antisceggia

255⁰⁰ €

+ IVA

**DW333KT-QS
SEGHE
TTO ALTERNATIVO
701W
IMPUGNATURA SUL CORPO**

- Corse min 800-3100
- Max taglio legno /alluminio/acciaio 130/20/10mm

DOTAZIONE: 4 lame, accessorio per aspirazione, protezione antigraffio, inserto antisceggia



LEGNO



160^{.00} €
+ IVA

DCE530N-XJ PISTOLA TERMICA 18V XR

Versione senza batterie
e caricabatteria in
scatola di cartone



214^{.00} €
+ IVA

DWE315KT-QS MULTIFUNZIONE AD OSCILLAZIONE 300W

- Orbite/min 0-22000
- Angolo oscillazione 1.6°
- Aggancio rapido accessori
- Luce LED

DOTAZIONE: vari accessori, TSTAK



482^{.00} €
+ IVA

DCS356P2-QW MULTIFUNZIONE AD OSCILLAZIONE 18V XR 5AH

- Orbite/min 0-15000/17000/20000
- Aggancio rapido accessori
- Luce LED

DOTAZIONE: accessori, 2 batterie 18V XR 5Ah,
caricabatterie, TSTAK



93^{.00} €
+ IVA

D26414-QS PISTOLA TERMICA DIGITALE 2000W



390^{.00} €
+ IVA



DCW200P2-QW LEVIGATRICE ORBITALE ¼ DI FOGLIO 18V XR 5AH



405^{.00} €
+ IVA



DCW210P2-QW LEVIGATRICE ROTO-ORBITALE 125MM 18V XR 5AH

250^{.00} €
+ IVA



DW682K-QS FRESATRICE PER LINGUETTE 600W



152^{.00} €
+ IVA

DWE6411Z-IT LEVIGATRICE ORBITALE ¼ DI FOGLIO 230W + PIASTRA PER PERSIANE



135^{.00} €
+ IVA

DWE6423-QS LEVIGATRICE ROTO-ORBITALE 125mm 280W

230^{.00} €
+ IVA



DW680-QS PIALLETTO 600W



385^{.00} €
+ IVA

D26204K-QS ELETTROFRESATRICE BASE FISSA E AD AFFONDAMENTO 900W

- Velocità 16000÷27000 giri/min
- Diametro pinza 6÷8mm
- Max diametro fresa 36mm
- Max prof. di affondamento 55mm



540^{.00} €
+ IVA

DWE625-QS ELETTROFRESATRICE ELETTRONICA 12.7MM 2300W

- Velocità 9.000-22.000 Giri/min
- Diametro pinza 6 - 12.7mm
- Max diametro fresa 50mm
- Max affondamento 80mm



595^{.00} €
+ IVA

DWE627KT-QS ELETTROFRESATRICE ELETTRONICA 12.7MM 2300W CON INTERRUPTORE DI SICUREZZA

- Velocità 9.000-22.000 Giri/min
- Diametro pinza 6 - 12.7mm
- Max diametro fresa 50mm
- Max affondamento 80mm

EXTREME[®] WORKSHOP LEGNO



- CARBURO PREMIUM C4
Fino a 5 riaffilature
- LAMA TAGLIATA AL LASER
Ottimo equilibrio
- FESSURE D'ESPANSIONE
Minor flessione del disco
- FESSURE ARMONICHE
Riduzione del rumore
- DENTI IN CARBURO ULTRA AFFILATI
- ANGOLI DI AFFILATURA OTTIMIZZATI
Minor rischio di scheggiatura

EXTREME[®] 2x^{LOW LIFE}



- CARBURO DI NUOVA GENERAZIONE C3
Fino a 3 riaffilature (vs gamma Construction)
- FESSURE D'ESPANSIONE RIEMPIE DI RESINA
Riduce rumore e vibrazioni
- DENTE SOTTILE
Minor sforzo, ideale per seghe cordless
- CORPO PIENO
Ridotta ondulazione, taglio più dritto
- DENTI IN CARBURO ULTRA AFFILATI
- ANGOLI AFFILATURA OTTIMIZZATI
Ridotto rischio di scheggiatura

XR EXTREME RUNTIME



- IDEALI PER SEGHE A BATTERIA
Doppio dei tagli con una carica, per utensili FlexVolt
- CARBURO DI NUOVA GENERAZIONE C3
Fino a 3 riaffilature
- DENTE SOTTILE
Minor sforzo, ideale per seghe cordless
- CORPO PIENO Ridotta ondulazione, taglio più dritto
- FESSURE D'ESPANSIONE
Riduce rumore e vibrazioni
- ANGOLI D'AFFILATURA BREVETTATI
Tagli più veloci con minor sforzo

TABELLA COMPARATIVA

MATERIALI CONSIGLIATI



CODICE	Ø LAMA/FORO MM	N° DENTI	GEOMETRIA DENTE	ANGOLO DENTE	LAMA	TIPO TAGLIO	€
DT1930-QZ	152/20	24	Alternato	10°	Construction / Edilizia	Universale	18,60
DT1931-QZ	160/20	18	Alternato	20°	Construction / Edilizia	Extra Veloci	17,60
DT1932-QZ	160/20	30	Alternato	10°	Construction / Edilizia	Universale	19,40
DT1086-QZ	165/20	48	Trapezoidale	5°	LEGNO	Puliti	62,90
DT1090-QZ	165/20	48	Alternato	5°	LEGNO	Puliti	53,10
DT1934-QZ	165/20TK*	24	Alternato	10°	Construction / Edilizia	Universale	18,70
DT1935-QZ	165/20	30	Alternato	10°	Construction / Edilizia	Universale	19,70
DT1937-QZ	165/30	30	Alternato	10°	Construction / Edilizia	Universale	21,30
DT1942-QZ	184/30	30	Alternato	10°	Construction / Edilizia	Universale	24,00
DT4092-QZ	184/16	48	Trapezoidale	-5°	LEGNO	Ultra puliti	82,60
DT10302-QZ	184/16	24	Alternato	18°	EXTREME [®] LEGNO	Universale	37,40
DT10303-QZ	184/16	40	Alternato	18°	EXTREME [®] LEGNO	Puliti	47,40
DT1943-QZ	190/30	18	Alternato	20°	Construction / Edilizia	Extra Veloci	24,20
DT1944-QZ	190/30TK*	24	Alternato	16°	Construction / Edilizia	Universale	24,90
DT1945-QZ	190/30	40	Alternato	10°	Construction / Edilizia	Universale	26,20
DT4094-QZ	190/30	48	Trapezoidale	-5°	LEGNO	Ultra puliti	76,80
DT10304-QZ	190/30	24	Alternato	18°	EXTREME [®] LEGNO	Universale	38,30
DT99562-QZ	190/30	24	Alternato	25°	XR EXTREME RUNTIME	Universale	43,10
DT99563-QZ	190/30	36	Alternato	25°	XR EXTREME RUNTIME	Puliti	58,00
DT4394-QZ	190/30	40	Alternato	10°	EXTREME [®] LEGNO	Puliti	61,30
DT1954-QZ	235/30	24	Alternato	20°	Construction / Edilizia	Extra Veloci	27,10
DT1938-QZ	184/16	18	Alternato	20°	Construction / Edilizia	Extra Veloci	20,40
DT1939-QZ	184/16	24	Alternato	16°	Construction / Edilizia	Universale	22,10
DT1940-QZ	184/16	24	Alternato	10°	Construction / Edilizia	Universale	24,00
DT1472-QZ	190/30	4	Piatto	12°	EXTREME [®] MULTIMATERIAL		63,00
DT1957-QZ	250/30	48	Alternato	10°	Construction / Edilizia	Universale	36,40
DT4287-QZ	250/30	80	Trapezoidale	-5°	LEGNO	Ultra puliti	98,10
DT4351-QZ	250/30	60	Alternato	10°	LEGNO	Puliti	103,00
DT1474-QZ	250/30	12	Piatto	12°	EXTREME [®] MULTIMATERIAL		206,00
DT4280-QZ	260/30	80	Trapezoidale	-5°	LEGNO	Ultra puliti	92,40
DT1916-QZ	305/30	80	Trapezoidale	-5°	METALLO	Extra Veloci	184,80
DT1959-QZ	305/30	48	Alternato	10°	Construction / Edilizia	Universale	51,50
DT1960-QZ	305/30	60	Alternato	-5°	Construction / Edilizia	Universale	55,60
DT4218-QZ	305/30	72	Incaavato	10°	LEGNO	Ultra puliti	151,20
DT4260-QZ	305/30	60	Alternato	-5°	LEGNO	Puliti	88,30
DT4288-QZ	305/30	80	Trapezoidale	-5°	LEGNO	Extra Veloci	123,40
DT4290-QZ	305/30	96	Trapezoidale	-5°	LEGNO	Extra Veloci	135,70
DT4331-QZ	305/30	60	Alternato	-5°	LEGNO	Puliti	116,10
DT4340-QZ	305/30	48	Alternato	10°	LEGNO	Puliti	87,50
DT1926-QZ	355/25.4	66	Trapezoidale	1,5°	METALLO	Extra Veloci	190,50
DT1927-QZ	355/25.4	90	Trapezoidale	1,5°	METALLO	Extra Veloci	210,10
DT1922-QZ	355/25.4	90	Trapezoidale	10°	METALLO	Extra Veloci	340,10

LAME CIRCOLARI

COSTRUCTION / EDILIZIA

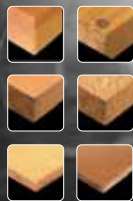

- **CARBURIO C2**
Maggior resistenza a scheggiature e rotture
- **DENTE SOTTILE**
Minor sforzo, ideale per seghe cordless
- **CORPO PIENO**
Ridotta ondulazione, taglio più dritto
- **DENTI ULTRA AFFILATI**
Minor rischio di scheggiatura

MULTI MATERIAL



- **FESSURE ANTIVIBRAZIONE**
Miglior finitura del taglio e riduzione del rumore



METALLO

ACCIAIO
Realizzato con il 12% di carburo di titanio, tagliano CON FACILITÀ l'acciaio. Denti trapezoidali per tagli puliti e senza sbavature. Fessure d'espansione per dissipare il calore e tripla brasatura garantiscono maggior resistenza prolungandone la durata.

ACCIAIO INOSSIDABILE (Inox)
Realizzate in carburo per tagliare con facilità acciaio ed acciaio inossidabile, per durare a lungo e ridurre le scheggiature.

ALLUMINIO
Per tagliare alluminio e metalli non ferrosi inclusi ottone e rame. I denti in carburo di tungsteno mantengono a lungo l'affilatura ed un bordo antiaderente riduce l'attrito. Lo spessore dei denti permette tagli veloci ed ultra-sottili.

LEGNO DURO	LEGNO	LEGNO CON CHIODI	LEGNO MORBIDO	COMPENSATO	LAMINATO	MDF	IMPIALLACCIATO	PANNELLI RIVESTITI	PLASTICA	ALLUMINIO	METALLO/ACCIAIO	ACCIAIO INOX	COMPOSITO DECK	FIBRO CEMENTO	CODICE
	•		•												DT1930
	•		•												DT1931
	•		•												DT1932
•	•		•	•	•	•									DT1086
•	•		•												DT1090
	•	•	•												DT1934
	•	•	•												DT1935
	•	•	•												DT1937
	•	•	•												DT1942
							•	•	•	•					DT4092
•				•	•	•									DT10302
•				•	•	•									DT10303
	•	•	•												DT1943
	•	•	•												DT1944
	•	•	•												DT1945
							•	•	•	•					DT4094
•				•	•	•									DT10304
•			•	•	•	•									DT99562
•			•	•	•	•									DT99563
•			•	•	•	•							•		DT4394
	•	•	•												DT1954
	•	•	•												DT1938
	•	•	•												DT1939
	•	•	•												DT1940
														•	DT1472
	•	•	•												DT1957
•			•	•	•	•	•	•	•	•					DT4287
															DT4351
														•	DT1474
							•	•	•	•					DT4280
	•	•	•								•				DT1916
	•	•	•												DT1959
	•	•	•												DT1960
								•							DT4218
•				•	•	•									DT4260
							•	•	•	•					DT4288
							•	•	•	•					DT4290
•				•	•	•									DT4331
•	•			•	•	•									DT4340
											•				DT1926
											•				DT1927
												•			DT1922

PRODUCIAMO IN ITALIA - dal 1969

Oltre 50 anni di esperienza si uniscono alla continua ricerca di innovazione e eccellenza, e rendono lo stabilimento DEWALT di Perugia all'avanguardia nell'Industria 4.0

Lo sapevi che...

Lo stabilimento DEWALT Industrial Tools di Perugia è specializzato nella produzione di elettrotensili professionali, iniziata nel 1969 con troncatrici e seghe combinate.

Oggi i prodotti realizzati, sia a filo che a batteria, sono ancora principalmente per il settore della lavorazione legno (troncatrici, seghe a banco, rifilatori) ma anche per l'edilizia (martelli demolitori) e la carpenteria metallica.



DWS774-QS
TRONCATRICE
RADIALE
216MM
1600W

	X	Y
90°/90°	250 mm	60 mm
45°/90°	170 mm	60 mm
90°/45°	250 mm	48 mm



415⁰⁰ €
+ IVA

DWS771-QS
TRONCATRICE
RADIALE
216MM
1600W

	X	Y
90°/90°	270 mm	60 mm
45°/90°	190 mm	60 mm
90°/45°	270 mm	48 mm



645⁰⁰ €
+ IVA

DWS778-QS
TRONCATRICE
RADIALE
250MM
1600W

	X	Y
90°/90°	305 mm	85 mm
45°/90°	215 mm	85 mm
90°/45°	305 mm	58 mm



660⁰⁰ €
+ IVA

DW712-QS
TRONCATRICE
RADIALE
216MM
1600W

	X	Y
90°/90°	300 mm	70 mm
45°/90°	212 mm	70 mm
90°/45°	300 mm	50 mm

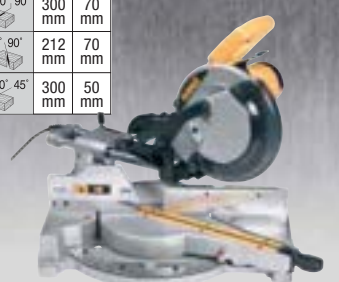

915⁰⁰ €
+ IVA

MACCHINE STAZIONARIE

DWS727-QS
TRONCATRICE
RADIALE
250MM
1600W

90° 90°	290 mm	90 mm	305 mm	77 mm
45° 90°	200 mm	90 mm	210 mm	77 mm
90° 45°	290 mm	60 mm	305 mm	50 mm
45° 45°	200 mm	60 mm	210 mm	50 mm



915^{.00} €

+ IVA

DWS780-QS
TRONCATRICE
RADIALE
305MM
A DOPPIA
INCLINAZIONE
1675W

90° 90°	303 mm	110 mm	345 mm	76 mm
45° 90°	200 mm	112 mm	244 mm	76 mm
90° 45°	268 mm	63 mm	345 mm	44 mm



1.150^{.00} €

+ IVA

D27113-QS
TRONCATRICE
TESTA FISSA
CON PIANETTO
305MM

755^{.00} €

+ IVA



D27112-QS
TRONCATRICE
RADIALE
CON PIANETTO
305MM
1600W

950^{.00} €

+ IVA



DE7033-XJ
CAVALLETTO
DI SUPPORTO
UNIVERSALE

149^{.00} €

+ IVA



DWE7485-QS
SEGA A BANCO
210MM
1850W

629^{.00} €

+ IVA



DWE7492-QS
SEGA A BANCO
250MM
2000W

775^{.00} €

+ IVA



D27107-QS
SEGA
COMBINATA
305MM
2000W

1.670^{.00} €

+ IVA



D27300-QS
PIALLA A FILO
E SPESSORE
2100W

1.899^{.00} €

+ IVA



DW733-QS
PIALLA A
SPESSORE
317MM
1800W

799^{.00} €

+ IVA



SPECIALE PNEUMATICA

DPC17PS-QS COMPRESSORE 17 LT CON RUOTE

- Motore senza olio
- Potenza motore 2.5Hp/1.8Kw
- Aria aspirata 240 Lt/min
- Pressione massima 13.8 Bar
- FAD 141 Lt/min @ 6.23Bar
- 2 connettori uscita aria EU universali
- Maniglia telescopica
- DOTAZIONE:
Tubo flessibile 10Mt

495.⁰⁰ €

+ IVA



DPC10RC-QS COMPRESSORE 10L

- Motore senza olio
- Potenza motore 2Hp
- Aria aspirata 216 Lt/min
- FAD 82 Lt/min
- Peso 17.5Kg
- DOTAZIONE:
Tubo flessibile 10Mt

280.⁰⁰ €

+ IVA

DPC6MRC-QS COMPRESSORE 6L

- Motore senza olio
- Potenza motore 1.5Hp
- Aria aspirata 170 Lt/min
- FAD 75 Lt/min
- Peso 10.5Kg
- DOTAZIONE: Tubo flessibile 5Mt

208.⁰⁰ €

+ IVA

DPN90C-XJ CHIODATRICE 90mm

- Corpo in magnesio
- Regolazione profondità
- Lunghezza chiodo 50-90mm
- Ø Chiodo 2.5-3.1mm
- Testa chiodo 7.2mm
- Valigetta

450.⁰⁰ €

+ IVA

DPN1850PP-XJ GROPPINATRICE 18G Precision point

- Sistema senza olio
- Corpo in magnesio
- Regolazione profondità
- Larghezza groppino 1.2mm
- Lunghezza groppino 15-50mm
- Valigetta

150.⁰⁰ €

+ IVA

DPN2330-XJ GROPPINATRICE 23G

- Corpo in alluminio
- Regolazione potenza
- Scarico aria posteriore
- Larghezza groppino 0.6mm
- Lunghezza groppino 10-30mm
- Valigetta

153.⁰⁰ €

+ IVA

DPS8016-XJ CUCITRICE SERIE 80

- Corpo in alluminio
- Regolazione potenza
- Scarico aria posteriore
- Larghezza graffa 12.8mm
- Lunghezza graffa 4-16mm
- Valigetta

182.⁰⁰ €

+ IVA

APPLICAZIONI SPECIALI

D36000-QS TAGLIAPIASTRELLE AD ACQUA 1600W

- Ø lama/foro 254/25.4 mm
- Velocità 4200 Giri/min
- Max prof. taglio 80mm
- Max cap. di taglio 940mm
- Max cap. di taglio diagonale 635mm

DOTAZIONE: Vasca e supporti laterali raccogli acqua, pompa acqua.



1.350^{.00} €
+ IVA



**IN DOTAZIONE
GAMBE DI
SUPPORTO
D240001-XJ**

DCN662D2-QW GROPPINATRICE 16GA BRUSHLESS 18V XR 2AH

- Lunghezza chiodi: 32-64mm
- Ø chiodi: 1.6mm
- Angolazione chiodi: 0°

DOTAZIONE: 2 batterie 18V XR 2Ah, caricabatterie e valigetta



680^{.00} €
+ IVA

DWD024KS-QS TRAPANO A PERCUSSIONE 701W

- Velocità 0-2600 giri/min
- Coppia 12Nm
- Mandrino 1.5-13 mm
- In valigetta



109^{.00} €
+ IVA

DCN45RND2-QW CHIODATRICE PER TETTI E MANUTENZIONE GENERALE 18V XR 2AH

- Lugh. chiodi: 19-45 mm
- Ø chiodi: 3.1mm
- Angolazione chiodi: 15°
- Capacità: 120 chiodi
- Velocità: 3 chiodi/sec

DOTAZIONE: 2 batterie 18V XR 2Ah, caricabatterie e valigetta



18V XR

725^{.00} €
+ IVA



DWD241-QS MISCELATORE DOPPIA IMPUGNATURA 1800W

- 3 velocità
225-725 giri/min
- Attacco femmina M14
- Max Ø frusta 160mm



249^{.00} €
+ IVA

DCN890P2-QW CHIODATRICE BRUSHLESS PER CEMENTO 18V XR 5AH

- Lugh. chiodi: 13-57mm
- Ø chiodi: 2.6-3.7mm
- Angolazione chiodi: 15°
- Capacità: 30 chiodi
- Velocità: 3 chiodi/sec

DOTAZIONE: 2 batterie 18V XR 5Ah, caricabatterie e valigetta



18V XR

955^{.00} €
+ IVA



180^{.00} €
+ IVA

DWC410-QS TAGLIAPIASTRELLE AD ACQUA 110MM 1300W

- Velocità 13000 giri/min
- Max profondità taglio 90/45° 34/19mm



255^{.00} €
+ IVA

DWD524KS-QS TRAPANO PERCUSSIONE 1100W

- 2 Velocità 0-1250/3500 giri/min
- Coppia serraggio 40/20 Nm
- Frizione meccanica
- Valigetta



322^{.00} €
+ IVA

D21570K-QS TRAPANO PERCUSSIONE / CAROTATORE A SECCO 1300W

- Mandrino 1-16mm
- 2 Velocità 0-1250/3500 giri/min
- Max Ø corona diamantata 127mm
- Valigetta



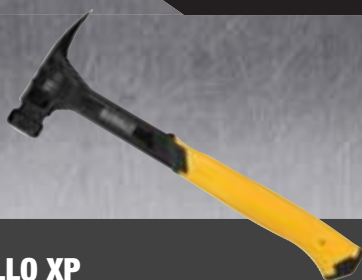

MARTELLINO XP

CODICE	DESCRIZIONE	€ s/IVA
DWHT51003-0	Martello gr 454	34,80 €
DWHT51004-0	Martello gr 567	37,20 €
DWHT51005-0	Martello gr 624	39,50 €



LIVELLE A SEZIONE RETTANGOLARE

CODICE	DESCRIZIONE	€ s/IVA
DWHT0-43224	Livella 60 cm	34,80 €
DWHT0-43248	Livella 120 cm	50,30 €
DWHT0-43172	Livella 180 cm	75,40 €



27⁵⁰ €
+ IVA

DWHT0-43003 LIVELLA TORPEDO 25 CM

In alluminio estruso con 1 bolla verticale e 1 bolla orizzontale ad alta resistenza, inserite in una struttura in ABS rinforzato. Ulteriore bolla regolabile con indicazione dell'angolo di inclinazione + - 90°.



17⁹⁰ €
+ IVA

DWHT42525-0 LIVELLA TORPEDO COMPATTA 16,5 CM

In alluminio estruso con 1 bolla orizzontale 1 verticale e 1 ulteriore orizzontale con inclinazione di 1,5° per posa di tubi di drenaggio e grondaie. 3 magneti nella parte superiore.



FLESSOMETRO TOUGH TAPE

CODICE	DESCRIZIONE	€ s/IVA
DWHT36917-0	Flessometro 5m nastro 32mm	25,20 €
DWHT36928-0	Flessometro 8m nastro 32mm	27,60 €



FLESSOMETRO COMPATTO

CODICE	DESCRIZIONE	€ s/IVA
DWHT38114-0	Flessometro Compatto 5m - nastro 28 mm	16,20 €
DWHT38128-0	Flessometro Compatto 8m - nastro 28 mm	18,40 €



5⁴⁰ €
+ IVA

DWHT36098-1 FLESSOMETRO TASCABILE 3M

Flessometro tascabile da 3m compatto con nastro da 13mm. Clip d'aggancio alla cintura e inserto magnetico nella cassa. Ideale per uso quotidiano.

UTENSILI MANUALI

11^{.60} €

+ IVA



DWHTO-10249 CUTTER AUTOBLOCCANTE MM 18

Con rotella bloccalama in punta per ulteriore sicurezza. Fornito con 3 lame a spezzare al Carburo di tungsteno. Barra porta lama in acciaio inox e caricamento automatico della lama. Il serbatoio può contenere fino a 6 lame.

14^{.20} €

+ IVA



DWHTO-10250 CUTTER AUTOBLOCCANTE MM 25

Con rotella bloccalama in punta per ulteriore sicurezza. Fornito con 3 lame a spezzare al Carburo di tungsteno. Barra porta lama in acciaio inox e caricamento automatico della lama. Il serbatoio può contenere fino a 6 lame.

13^{.30} €

+ IVA



DWHTO-10295 COLTELLO A LAMA RETRATTILE

Impugnatura bi-material e inserto poggia dito in gomma. Pulsante di regolazione della lama per varie profondità di taglio. Cambio lama rapido. Dotato di elemento taglia spago e di moschettone.

20^{.70} €

+ IVA



DWHTO-10313 COLTELLO SPORT PIEGHEVOLE

Coltello maneggevole, leggero con una lama uso intenso da 82 mm in acciaio inox con una parte seghettata per materiali più resistenti e per uso come spelafili.

26^{.40} €

+ IVA



DWHTO-20547 SEGHETTO PER METALLO "5 IN 1"

Con possibilità di inserire la lama direttamente nel manico o nel telaio per uso anche in spazi ristretti. Serbatoio per lame di ricambio all'interno del seghetto. Tensione della lama regolabile fino a 150 kg.

9^{.00} €

+ IVA



DWHT20327-0 MINISEGHETTO PER FERRO

Un utensile versatile e compatto con cambio lama senza utensili e possibilità di regolazione della tensione.



MORSETTI A BARRA

CODICE	DESCRIZIONE	€ s/IVA
DWHTO-83192	Morsetto a barra mm 150 kg 135	19,80 €
DWHTO-83193	Morsetto a barra mm 300 kg 135	22,20 €
DWHTO-83194	Morsetto a barra mm 600 kg 135	25,70 €
DWHTO-83195	Morsetto a barra mm 910 kg 135	28,70 €
DWHTO-83185	Morsetto a barra XL mm 300 kg 272	30,60 €
DWHTO-83186	Morsetto a barra XL mm 600 kg 272	39,50 €
DWHTO-83187	Morsetto a barra XL mm 910 kg 272	44,30 €

58^{.60} €

+ IVA



DWMT81610-0 SET 50 PZ CHIAVI A BUSSOLA COMPATTO ATTACCO 1/4"

Set composto da chiavi a bussola esagonali con attacco 1/4" mm 4, 4,5, 5, 5,5, 6, 7, 8, 9, 10, 11, 12, 13, 14.

Chiavi a bussola esagonali in pollici con attacco 1/4" SAE 5/32", 3/16", 7/32", 1/4", 9/32", 5/16", 11/32", 3/8", 7/16", 1/2", 9/16"

Accessori: Cricchetto 72 denti att. 1/4"; Prolunga mm 75 attacco 1/4"; Prolunga mm 150 att. 1/4"; Maniglia porta bussole; Bussola porta inserti; 22 inserti

SISTEMI PORTAUTENSILI

TOUGHSYSTEM® 2.0

IN CONDIZIONI ESTREME



ELEVATO SPAZIO
INTERNO UTILE



SISTEMA
AGGANCI/SGANCIO
LATERALE BREVETTATO



CHIUSURE FRONTALI
RINFORZATE

ADATTATORE **TOUGHSYSTEM®**

TSTAK™
COMPATIBLE

**TOUGH
CASE+**
COMPATIBLE

TOUGHSYSTEM®
COMPATIBLE

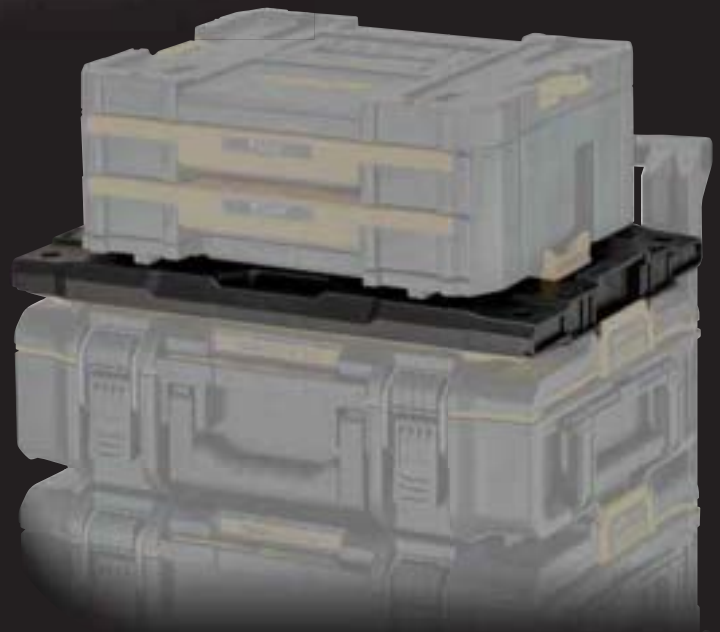

TSTAK™

COMPONI I PORTAUTENSILI

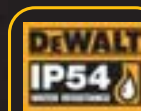

IP54 PROTEZIONE
ACQUA/POLVERI



CHIUSURE
METALLICHE
MAGGIORATE



AGGANCI/SGANCIO
LATERALE CON
SPINA METALLICA



ALLOGGIAMENTO
PER TAG DI
LOCALIZZAZIONE

NOVITÀ

229.⁰⁰ €
+ IVA

TOUGHSYSTEM®

IP55 



**DWST83471-QW
VALIGIA CARICABATTERIA A 2 INGRESSI**

- 2 postazioni di ricarica simultanee 4°
- Alloggiamento batteria di scorta
- Indicatore stato di carica interno ed esterno
- Ventilazione combinata
- Porta USB 1X Type A, 1X Type C
- Chiusura in metallo
- Formato mezzo modulo

45.⁰⁰ €
+ IVA

TOUGHSYSTEM®

IP65 



**DWST08035-1
MEZZO FONDO TOUGHSYSTEM**

- Vasca interna amovibile
- Divisori interni
- Cerniere e chiusure in acciaio
- Formato mezzo modulo

NOVITÀ

109.⁰⁰ €
+ IVA

TSTAK™

IP54 



**DWST17871-1
BAULE CON RUOTE**

- Capacità 136 lt
- Doppia apertura, totale o apertura superiore ad accesso rapido
- Doppio occhiello per lucchetto
- Maniglione a scomparsa
- Cerniere e chiusure in acciaio

NOVITÀ

119.⁰⁰ €
+ IVA



**DWST08017-9
COMBINATA TOUGHSYSTEM - TSTAK**

- Cassetta portautensili media Toughsystem DWST83294-1
- Adattatore Toughsystem-TSTAK DWST08017-1
- Valigia fonda TSTAK DWST83346-1

**DWST08017-1
ADATTATORE TOUGHSYSTEM - TSTAK**

Consente di adattare i moduli del sistema Tstak a quelli Toughsystem 2.0 anche nella misura 1/3 e 2/3

19.⁰⁰ €
+ IVA

**TSTAK™
COMPATIBLE**

**TOUGH
CASE+
COMPATIBLE**

**TOUGHSYSTEM®
COMPATIBLE**

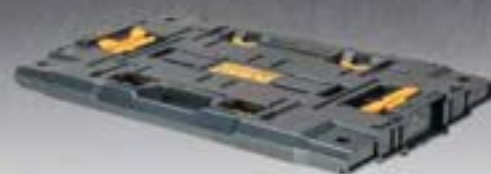

NOVITÀ

TOUGHSYSTEM® 2.0

TOUGHSYSTEM®
COMPATIBLE



105.⁰⁰ €
+ IVA

DWST83522-1
BORSA TRACOLLA 22"
NYLON 1600DEN
MULTITASCHE

TOUGHSYSTEM®
COMPATIBLE



85.⁰⁰ €
+ IVA

DWST83524-1
BORSA TRACOLLA 11"
NYLON 1600DEN
MULTITASCHE



31.⁰⁰ €
+ IVA

DWST83392-1
MEZZO ORGANIZER



58.⁰⁰ €
+ IVA

DWST83394-1
UNITÀ ORGANIZER CON
10 CONTENITORI PORTA MINUTERIA
(2 GRANDI E 8 PICCOLI)



56.⁰⁰ €
+ IVA

DWST83293-1
PORTAUTENSILI BASSO
555x385x180 mm



64.⁰⁰ €
+ IVA

DWST83294-1
PORTAUTENSILI MEDIO
555x385x317 mm



73.⁰⁰ €
+ IVA

DWST83342-1
PORTAUTENSILI ALTO
555x385x415 mm



125.⁰⁰ €
+ IVA

DWST83529-1
CASSETTA PORTA UTENSILI
CON DOPIO CASSETTO
305x355x535mm



DWST83408-1
13.⁰⁰ €
+ IVA

DWST83407-1
12.⁰⁰ €
+ IVA

DWST83408-1
CONTENITORE INTERNO ALTO
DWST83407-1
CONTENITORE INTERNO BASSO



130.⁰⁰ €
+ IVA

DWST83295-1
VASCA CON RUOTE
608x500x990 mm



246.⁰⁰ €
+ IVA

DWST83402-1
VASCA CON RUOTE +
UNITÀ BASSA + UNITÀ MEDIA



395.⁰⁰ €
+ IVA

DWST83401-1
TOUGHSYSTEM 2.0
COMPLETO

TSTAK™

E SOFT STORAGE

TSTAK™
COMPATIBILE



42.⁰⁰ €
+ IVA

DWST83541-1
BORSA TRACCOLLA 1600Dn,
MULTITASCHE



38.⁰⁰ €
+ IVA

DWST82968-1
ORGANIZER TSTAK V



52.⁰⁰ €
+ IVA

DWST83344-1
VALIGETTA CON
MANIGLIONE TSTAK I



38.⁰⁰ €
+ IVA

DWST83345-1
VALIGETTA TSTAK II



49.⁰⁰ €
+ IVA

DWST1-70705
VALIGETTA CON
CASSETTO TSTAK III



57.⁰⁰ €
+ IVA

DWST1-70706
VALIGETTA CON
2 CASSETTI TSTAK IV



37.⁰⁰ €
+ IVA

DWST83346-1 VALIGETTA
PROFONDA TSTAK VI



50.⁰⁰ €
+ IVA

DWST83343-1 VALIGETTA
PROFONDA CON MANIGLIONE



74.⁰⁰ €
+ IVA

DWST83520-1 ORGANIZER
+ VALIGIA PROFONDA



154.⁰⁰ €
+ IVA

DWST83517-1 TSTAK
TOWER KIT COMPOSTO
DA: VASCA CON RUOTE
+ TSTAK V + TSTAK I



144.⁰⁰ €
+ IVA

DWST83411-1 TSTAK
TOWER KIT COMPOSTO
DA: VASCA CON RUOTE
+ TSTAK V + TSTAK I



93.⁰⁰ €
+ IVA

DWST83347-1
VASCA FONDA
CON RUOTE



141.⁰⁰ €
+ IVA

DWST1-71196
TROLLEY TSTAK



56.⁰⁰ €
+ IVA

DWST1-71229
CARRELLO TSTAK



83.⁰⁰ €
+ IVA

DWST81690-1
ZAINO BACKPAK



71.⁰⁰ €
+ IVA

COMPATIBILE
TSTAK

DWST82991-1
BORSA TRACCOLLA
RETTANGOLARE



71.⁰⁰ €
+ IVA

COMPATIBILE
TSTAK

DWST82990-1
BORSONE APERTO
RETTANGOLARE

ACCESSORI LAVORAZIONE DEI METALLI

EXTREME

95⁵⁰ €
+ IVA

29 PEZZI

**DT7926-XJ
SET FORARE METALLO**

Cassetta con 29 punte Extreme2 per forare. Metallo diametri da 1 a 13mm.

EXTREME

143⁹⁰ €
+ IVA

29 PEZZI

**DT4957-QZ
SET FORARE ACCIAIO INOX**

Cassetta con 29 punte Extreme COBALT forare. Acciaio inox ø da 1 a 13mm.

PUNTE METALLO EXTREME2

Adatte per forature su acciaio legato e non legato. Adatte per foratura su lamiere o materiali sottili dove sono richiesti fori senza sbavature. Ideali per utensili a filo o batteria fino a 900 N/mm²

CODICE	Ø	€ s/IVA
DT5038-QZ	2x3 mm	2,30 €
DT5042-QZ	2x4 mm	4,70 €
DT5046-QZ	5 mm	3,50 €
DT5048-QZ	6 mm	3,50 €
DT5052-QZ	8 mm	4,70 €

PUNTE COBALTO EXTREME

Per prestazioni eccezionali in foratura sull'acciaio INOX e materiali non ferrosi. Resistenza garantita fino a 1100 N/mm². Adatto su lamiere dove è richiesta precisione e su tubi senza alcun problema.

CODICE	Ø	€ s/IVA
DT4902-QZ	2x3 mm	4,70 €
DT4904-QZ	2x4 mm	4,70 €
DT4906-QZ	5 mm	5,80 €
DT4908-QZ	6 mm	5,80 €
DT4912-QZ	8 mm	8,20 €

PUNTE A GRADINO CON RIVESTIMENTO IN TITANIO

PUNTA AUTOCENTRANTE PER USO SU INOX-METALLI-PLASTICA

CODICE	Ø	€ s/IVA
DT5030-QZ	7 diam.	60,00 €
DT5031-QZ	8 diam.	102,50 €
DT90246-QZ	10 diam.	65,40 €
DT90247-QZ	13 diam.	107,90 €
DT90248-QZ	8 diam.	57,80 €

58⁹⁰ €
+ IVA

M4 M5 M6 M8 M10

UNA SOLA PASSATA PER FORARE, MASCHIARE, SVASARE

DT50060-QZ SET FORARE-MASCHIARE-SVASARE

Set di qualità composto da 5 punte attacco esagonale 1/4". Misure: M4-M5-M6-M8-M10. Il set ideale per installatori, meccanici, elettricisti, automotive.

SET ACCESSORI

TOUGH CASE+ CONNECTABLE CASES

EXTREME

39⁵⁰ €
+ IVA

10 PEZZI

**DT70753-QZ
SET FORARE SDS-PLUS**

Cassetta 10 punte SDS+ Extreme2 diametri: 5-6x2 mm da 110mm, 6x2-7-8-9-10-12 mm da 160mm

TOUGH CASE+ CONNECTABLE CASES

XLR

57⁹⁰ €
+ IVA

10 PEZZI

**DT70752-QZ
SET FORARE SDS-PLUS XLR**

Cassetta 10 punte SDS+ XLR diametri: 5-6x2 mm da 110mm, 6x2-6.5-8x2-10-12 mm da 160mm

TOUGH CASE+ CONNECTABLE CASES

EXTREME

39⁰⁰ €
+ IVA

9 PEZZI

**DT70751-QZ
SET FORARE LEGNO**

Set 9 mechie Extreme attacco esagonale 1/4" misure: 12, 14, 16, 18, 20, 22, 25, 28, 32 mm

DT70727-QZ **18⁰⁰ €** + IVA

DT70728-QZ **27⁸⁰ €** + IVA

DT70729-QZ **36⁵⁰ €** + IVA

TOUGH CASE+ CONNECTABLE CASES

SET PUNTE ELICOIDALI PER FORARE METALLO-LEGNO-PLASTICA CON CODOLO TRIANGOLARE AD ALTA TENUTA

PUNTE CON NUOVA GEOMETRIA, NUCLEO RINFORZATO E FINITURA «NERO E DORATA»

DT70727-QZ 14 punte - 1,1.5x2,2x2,2.5,3x2,3.5,4x2,5,6,8 mm

DT70728-QZ 19 punte - 1,1.5,2x2,2.5x2,3x2,3.5x2,4x2,5x2,5.5,6,7,8,10 mm

DT70729-QZ 23 punte - 1x2,1.5x2,2x2,2.5x2,3x2,3.5x2,4x2,4.5,5x2,6,7,8,9,10,12mm

SET ACCESSORI

IN DOTAZIONE



35^{.90} €
+ IVA

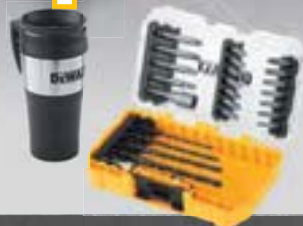

25 PEZZI

DT70707-QZ SET FORARE ED AVVITARE + TAZZA TERMICA

Cassetta con 25 pezzi: 15 inserti da 25mm: PH2 PZ2,3 T10,15,20,25,30 inserti da 50mm: PH2 PZ2,3 T25, 1 chiave a bussola 10mm, 1 guida magnetica, 4 punte metallo attacco 1/4" 3,4,5,6mm, 1 tazza termica



34^{.90} €
+ IVA



25 PEZZI

DT70730T-QZ SET AVVITARE

Cassetta con 25 pezzi: 15 inserti da 25mm: PZ2,3 - SL6 - T20,25,30, 5 inserti da 57mm: PH2 - PZ2,3, 3 inserti da 85mm: PH2-PZ2-T20, 1 bussola magnetica 8mm, 1 adattatore magnetico con guida Torsion



39^{.00} €
+ IVA



37 PEZZI

DT70731T-QZ SET AVVITARE

Cassetta con 37 pezzi: 22 inserti da 25mm: PH1,2,3 - PZ1,2,3 - T20,25,30 - SL 4, 11 inserti da 57mm: PH2 - PZ1,2,3 - T20,25, 2 inserti da 85mm: T20,25, 1 bussola magnetica in alluminio 10X, 1 adattatore magnetico con guida Torsion



39^{.00} €
+ IVA



32 PEZZI

DT70743T-QZ SET AVVITARE

Cassetta con 32 pezzi: 22 inserti da 25mm: PH2 -PZ1,2,3 - SL6 - T15,20,25,30, 5 inserti da 57mm: PH2 - PZ2,3 - T20,30, 3 inserti da 85mm: PH2-PZ2-T25, 1 bussola magnetica 8mm, 1 adattatore magnetico con guida Torsion



32 PEZZI

DT71516-QZ SET CRICCHETTO

Cassetta con 24 pezzi: 15 Inserti misti da 25mm, 6 Bussole, 1 Adattatore, 1 Porta inserti magnetico, 1 Cricchetto



6^{.90} €
+ IVA



10 PEZZI

DT7276-QZ SET AVVITARE

Set 10 inserti da 57mm Pozidriv: 2 PZ1 - 6 PZ2 - 2 PZ3

DT7275-QZ SET AVVITARE

Set 10 inserti da 57mm Torx: 3 T20 - 4 T25 - 3 T30

16^{.90} €
+ IVA



32 PEZZI

DT7969-QZ SET AVVITARE

Cassetta con 32 pezzi: 30 inserti misti da 25mm, 1 adattatore, 1 porta inserti magnetico

36^{.00} €
+ IVA



100 PEZZI

DT71566-QZ SET FORARE ED AVVITARE

Cassetta 100 pezzi: 12 punte metallo, 7 punte muratura, 5 punte legno, 1 adatt. magnetico, 53 inserti misti da 25mm, 15 inserti misti da 50mm, 2 seghe a tazza, 1 mandrino per sega a tazza, 3 inserti a bussola, 1 punta a svasare



24^{.50} €
+ IVA



40 PEZZI

DT70702-QZ SET AVVITARE

Cassetta 40 pezzi: 14 inserti da 50mm: PH1,2-PZ2,3-T15,20,25,30 21 inserti da 25mm: PH1,2,3-PZ2,3-T15,20,25,30 2 inserti da 85mm: PH2, PZ2 2 bussole esagonali 8,10 mm, 1 adattatore magnetico con guida



Sei un utilizzatore finale e vuoi contattarci?

Vai sul nostro sito:



<https://support.dewalt.com/hc/it-it/requests>



Oppure chiamaci: tel. 02.8295.3653 da Lunedì a Venerdì dalle 08:30 alle 19:30.

DEWALT® Stanley Black & Decker Italia S.r.l.
Via Energy Park 6 - 20871 Vimercate (MB)
Numero verde: 800.014353
Mail: dewalt.italia@dewalt.com



**MI PIACE
DEWALT**

Scopri le nostre
ultime novità,
promozioni e molto
altro su:



Distribuito Da:

www.DEWALT.com

Lo schema di colori giallo e nero è usato su DEWALT utensili elettrici e accessori come un marchio di fabbrica. DEWALT si riserva il diritto di modificare qualsiasi accordo in qualsiasi momento senza preavviso. Offerte disponibili fino ad esaurimento scorte.

Vuoi restare aggiornato sulle novità di DEWALT?
Registrati su MyDEWALT: www.DEWALT.com/MyDEWALT



REGISTRATI A

MY DEWALT